

**tomorrow**



new lighting atmospheres



**collection 2020**

Cattaneo, forte dei suoi quarant'anni di storia nel mondo dell'illuminazione, si racconta attraverso un rinnovato approccio comunicativo e una collezione di prodotti capaci non solo di illuminare gli ambienti, ma di generare nuove atmosfere.

Non una trasformazione, ma un'evoluzione basata sulla consapevolezza dei propri caratteri di unicità: valori autentici, che dall'azienda familiare, sono maturati in una realtà aziendale d'avanguardia, che desidera dare la propria personalissima risposta al presente evidenziando una predisposizione tecnologica al futuro.

La passione artigianale e la ricerca tecnologica generano corpi illuminanti che sono il connubio di dettagli perfetti. Ogni lampada è frutto di un processo creativo che fonde progettazione e ricerca generando oggetti di forte impatto estetico, capaci di rispondere alle esigenze funzionali e relazionarsi con l'utilizzatore dal punto di vista empatico e sensoriale.

Il concetto di made in Italy, oltre ad offrire cura artigianale e innovazione tecnologica, evolve in life style: i prodotti Cattaneo diventano strumento indispensabile nella progettazione degli spazi e promettono di emozionare attraverso il design della luce.

Cattaneo, with its forty years' experience in the lighting business, describes itself by means of a renovated communicative approach and a collection of products able to lighten spaces as well as giving birth to new atmospheres.

Not a transformation, but an evolution based on the awareness of its own peculiarities: genuine values that from a family business have grown wiser into a leading edge business institution, willing to give its own and personal answer to the present, outlining a real technological talent for future.

Artisan passion and technological research give birth to light fittings that represent the union of perfect details. Each light is the result of a creative process that blends design and research, creating objects with a strong aesthetical effect, able to respond to functional requirements and to relate themselves with the end user from an emphatic and sensory point of view.

The concept of Made in Italy does not simply mean artisan care and technological innovation, but evolves into "life style": Cattaneo products become the essential instrument to design spaces; their shaping of the light vows to get people emotional.

Cattaneo, mit seiner vierzigjährigen Geschichte in der Welt der Beleuchtung, erzählt seine Geschichte durch einen erneuerten kommunikativen Ansatz und eine Sammlung von Produkten, die nicht nur die Räume beleuchten, sondern auch neue Atmosphären erzeugen können.

Keine Transformation, sondern eine Evolution, die auf dem Bewusstsein der eigenen Eigenschaften der Einzigartigkeit basiert: authentische Werte, die aus dem Familienunternehmen stammen, sind zu einer avantgardistischen Geschäftsrealität gereift, die der Gegenwart ihre ganz persönliche Antwort geben will und eine technologische Prädisposition für die Zukunft aufzeigt.

Die Leidenschaft für Handwerk und technologische Forschung erzeugt Leuchten, die die Kombination perfekter Details sind. Jede Lampe ist das Ergebnis eines kreativen Prozesses, der Design und Forschung verbindet, Objekte mit starker ästhetischer Wirkung erzeugt, in der Lage ist, auf funktionale Bedürfnisse zu reagieren und sich aus einfühlsamer und sensorischer Sicht mit dem Benutzer zu befassen.

Das Konzept von Made in Italy entwickelt sich neben handwerklichem Können und technologischer Innovation auch zum Lifestyle: Cattaneo-Produkte werden zu einem unverzichtbaren Werkzeug bei der Gestaltung von Räumen und versprechen, durch die Gestaltung von Licht zu begeistern.

## Easy System



**Drop**  
p.11



**Mini Soft**  
p.19



**Time**  
p.29



**Mini Mercury**  
p.35



**Stretch**  
p 41

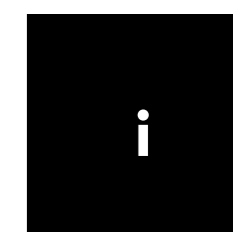

**Installation**  
p 46

## Head System



**Nuts**  
p 55



**Ball**  
p 61



**Cone**  
p 65

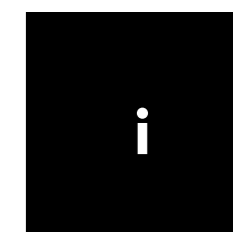

**Installation**  
p 68

## Line System



**E.R.**  
p 77



**Stone**  
p 83

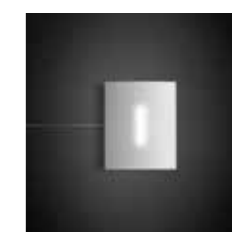

**Iron**  
p 87



**Installation**  
p 90



**Waterfalls**  
p 97



**Heron**  
p 105



**Dinamica**  
p 123



**Well**  
p 129

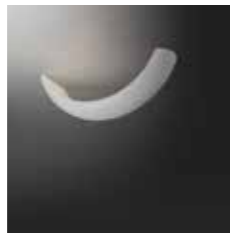

**Thesis**  
p 135



**Kami**  
p 143



**Volvit**  
p.153



**Basalt**  
p 159



**Ninfea**  
p 165



**Katana**  
p 171



**Nassa**  
p 183



**Olimpia**  
p 191

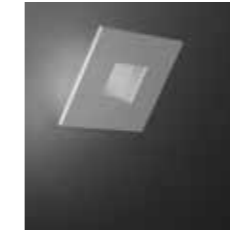

**Square**  
p 201



**Biquadro**  
p 209

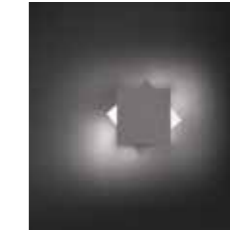

**Quadretto**  
p 215



**Cubick**  
p 221



**Tratto**  
p 235

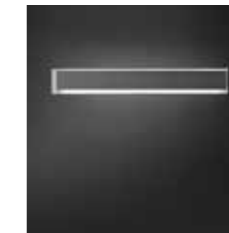

**Abbraccio**  
p 247



**Bolle**  
p 253



**Fuorisquadra**  
p 259



**Biscotto**  
p 265



**Plateau**  
p 271



**Adjustable**  
p 277



**Plane**  
p 283



**Spin**  
p 293



**Bambù**  
p 301



**Nuvola**  
p 309



**Mercury**  
p 319

# Easy System

design by C. Cattaneo



Sistema a sospensione personalizzabile. Grazie alla sua struttura il sistema Easy System ti permette di raggiungere luoghi d'illuminazione lontani dal tuo punto luce creando piacevoli installazioni.

Suspended system that can be customised. Thanks to its peculiar structure, Easy System makes it possible to bring light away from light sources, creating nice installations.

Flexibles System von Hängelampen, das einfach an persönliche Bedürfnisse angepasst werden kann. Die Struktur des Easy System bietet die Möglichkeit, das Licht weit weg vom Stromverteiler zu tragen und faszinierende Installationsformen zu kreieren.

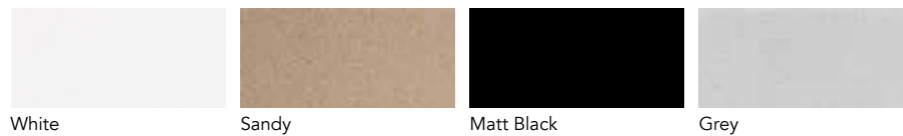

White

Sandy

Matt Black

Grey

# Drop

design by C. Cattaneo

Sospensione in alluminio tornito dalla classica forma di una goccia verniciato nelle colorazioni bianco, sabbia, nero e grigio fornita di un led da 8w 900 lumen dotata internamente di un rocchetto per il recupero del cavo in eccesso (fino a 2 metri) e con collegamento tramite jack per un veloce e sicuro collegamento alla sua base con alimentatore.

Suspension in turned aluminium with the classic shape of a drop, painted in white, sandy, black and grey provided with an 8W 900 lumens led, internally equipped with a spool for the recovery of the excess cable (up to 2 metres) and with connection via jack for a fast and secure connection to its power supply.

Aufhängung aus gedrehtem Aluminium in der klassischen Form eines Tropfens in Weiß, Sand, Schwarz und Grau mit einer LED 8w 900 Lumen, die innen mit einer Spule zur Rückgewinnung von überschüssigem Kabel (bis zu 2 Meter) und mit Anschluss über Buchse für eine schnelle und sichere Verbindung zu ihrem Sockel mit Stromversorgung ausgestattet ist.

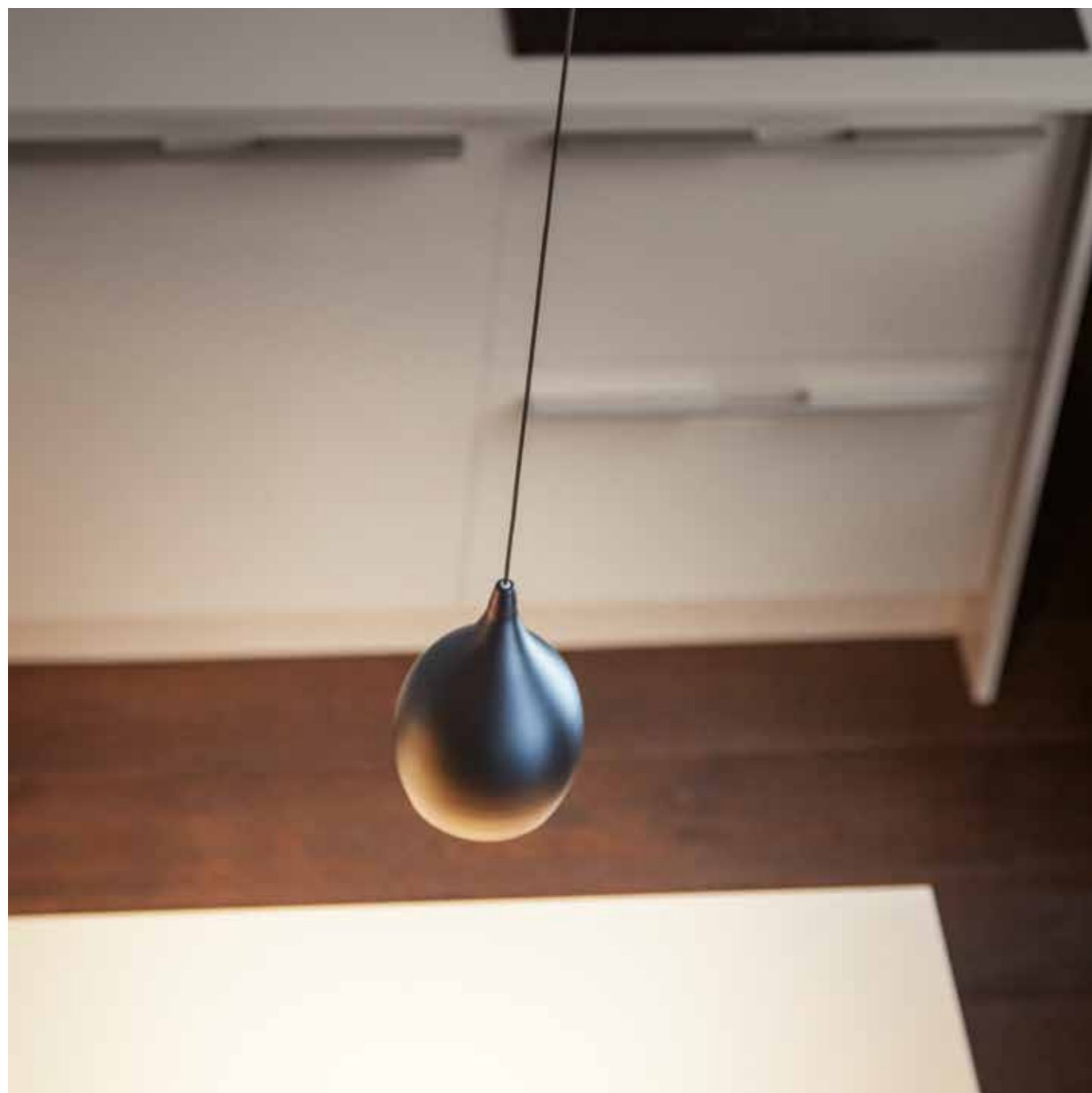

**Module**  
**786/13 S 2m / 3m / 5m / 7m / 10m**  
 LED 8W 700mA CC 900lm 3000°K  
 upon request 2700°/4000° K  
 CE Ⓢ IP20  
 Net weight 370gr - Gross weight 750gr  
 Volume m<sup>3</sup> 0,0084

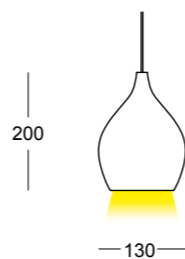

Module to be completed with  
 one of the bases on page 46









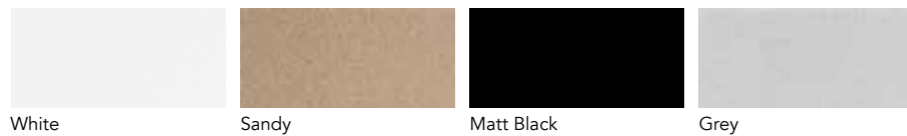

White

Sandy

Matt Black

Grey

# Mini Soft

design by C. Cattaneo

Sospensione in alluminio tornito verniciato nelle colorazioni bianco, sabbia, nero e grigio fornita di un led da 8w 900 lumen dotata internamente di un rocchetto per il recupero del cavo in eccesso (fino a 2 metri) e con collegamento tramite jack per un veloce e sicuro collegamento alla sua base con alimentatore.

Suspension in turned aluminium painted in white, sandy, black and grey, it's provided with an 8W 900 lumens led internally equipped with a spool for the recovery of the excess cable (up to 2 metres) and with connection via jack for a fast and secure connection to its power supply.

Aufhängung aus gedrehtem Aluminium, lackiert in Weiß, Sand, Schwarz und Grau, versehen mit einer LED von 8W 900 Lumen, die intern mit einer Spule zur Rückgewinnung von überschüssigem Kabel (bis zu 2 Meter) und mit Anschluss über Buchse für eine schnelle und sichere Verbindung zu ihrem Sockel mit Stromversorgung ausgestattet ist.



**Module**  
**785/16 S 2m / 3m / 5m / 7m / 10m**  
 LED 8W 700mA CC 900lm 3000°K  
 upon request 2700°/4000° K  
 CE  IP20  
 Net weight 320gr - Gross weight 730gr  
 Volume m<sup>3</sup> 0,0084

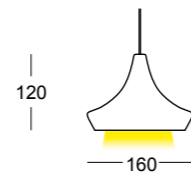

Module to be completed with  
 one of the bases on page 46

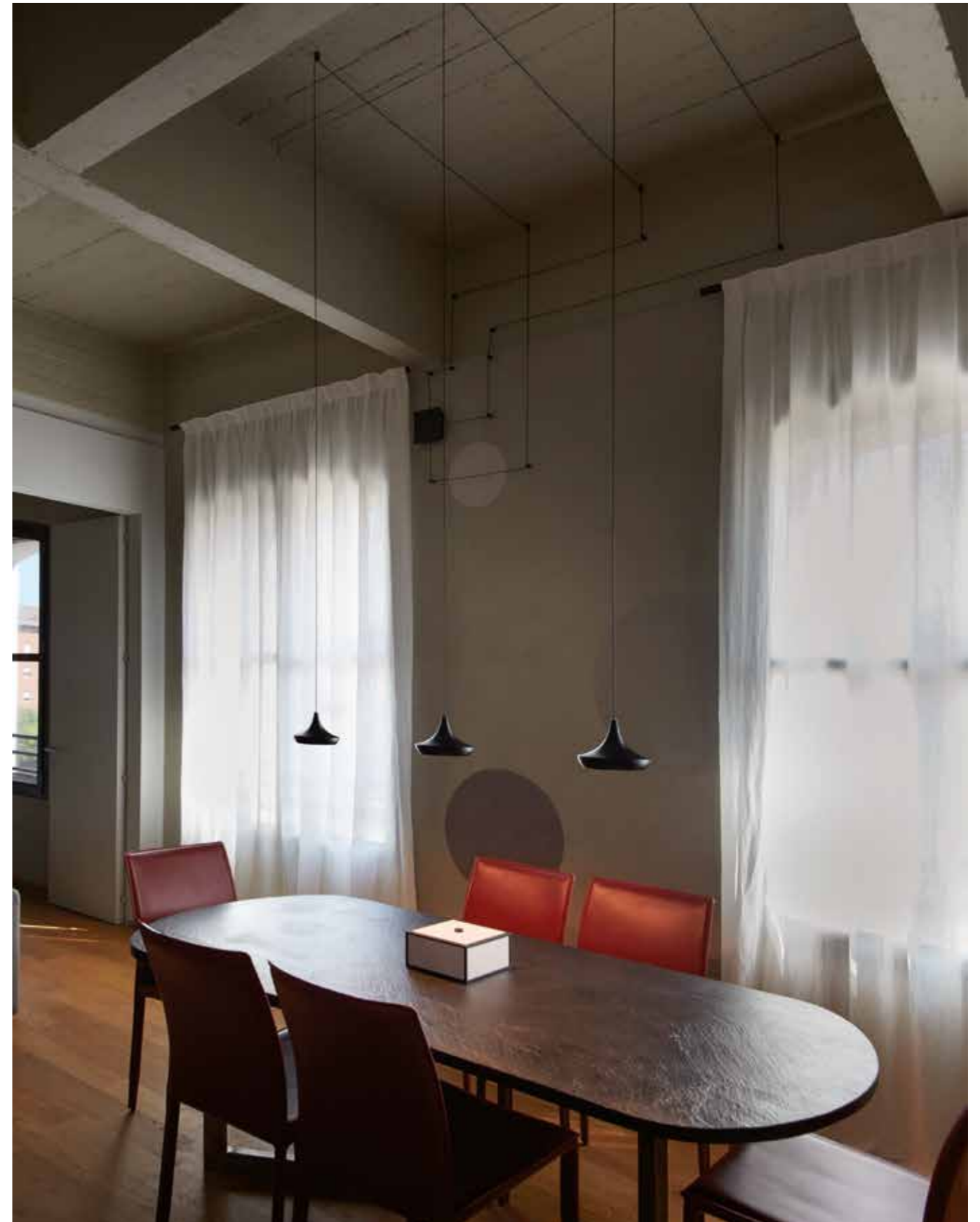

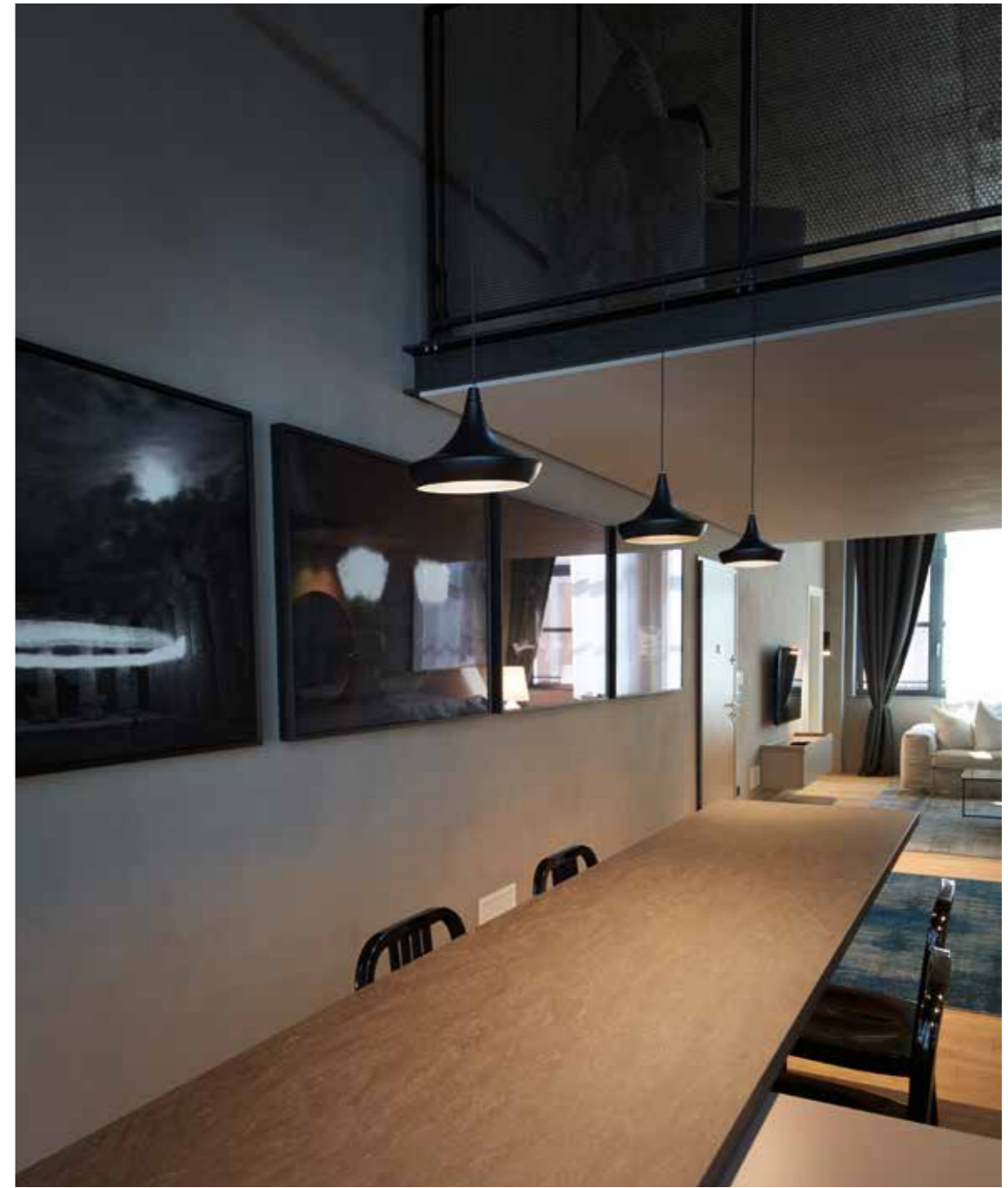





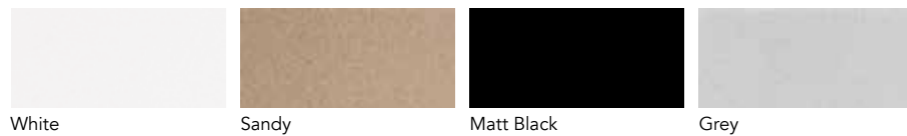

White

Sandy

Matt Black

Grey

# Time

design by C. Cattaneo

Sospensione in alluminio tornito verniciato nelle colorazioni bianco,sabbia,nero e grigio fornita di un led da 8w 900 lumen dotata internamente di un rocchetto per il recupero del cavo in eccesso (fino a 2 metri) e con collegamento tramite jack per un veloce e sicuro collegamento alla sua base con alimentatore.

Suspension in turned aluminium, painted in white, sandy, black and grey provided with an 8W 900 lumens led internally equipped with a spool for the recovery of excess cable (up to 2 metres) and with connection via jack for a fast and secure connection to its power supply.

Aufhängung aus gedrehtem Aluminium, lackiert in den Farben Weiß, Sand, Schwarz und Grau, mit einem Lumen von 8W 900 Lumen, das innen mit einer Spule zur Rückgewinnung von überschüssigem Kabel (bis zu 2 Meter) und mit Anschluss über eine Buchse für eine schnelle und sichere Verbindung mit dem Sockel mit Stromversorgung ausgestattet ist.



**Module**

**783/11S 2m / 3m / 5m / 7m / 10m**

LED 8W 700mA CC 900lm 3000°K

upon request 2700°/4000° K

CE  IP20

Net weight 370gr - Gross weight 680gr

Volume m<sup>3</sup> 0,0069

Module to be completed with  
one of the bases on page 46



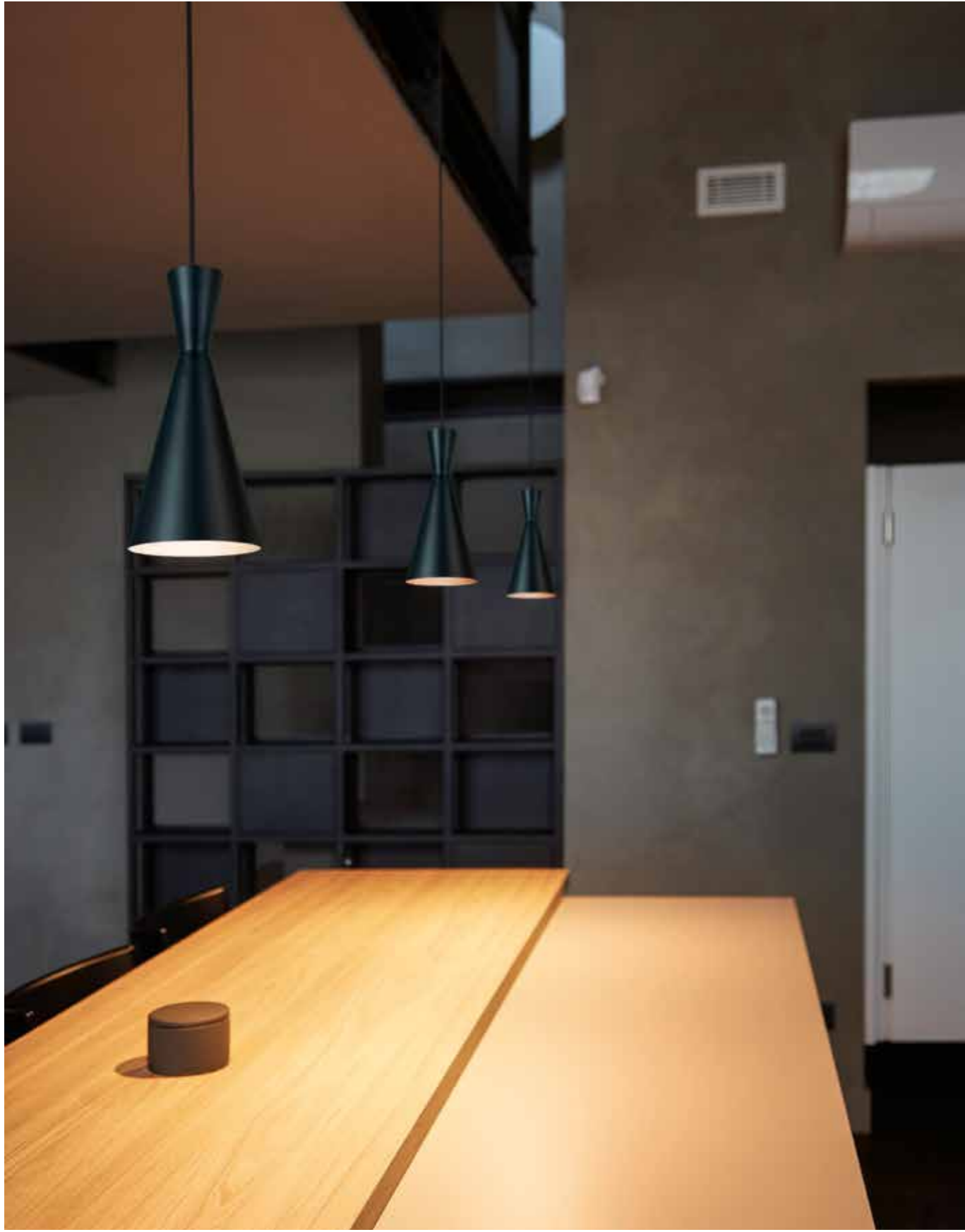

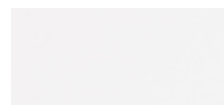

White

# Mini Mercury

design by C. Cattaneo

Sospensione in vetro soffiato in color biancolatte fornita di un led da 8w 900 lumen dotata internamente di un rocchetto per il recupero del cavo in eccesso (fino a 2 metri) e con collegamento tramite jack per un veloce e sicuro collegamento alla sua base con alimentatore.

Suspension with blown glass diffuser in milky-white color, equipped with an 8w 900 lumens led internally equipped with a spool for the recovery of excess cable (up to 2 metres) and with connection via jack for a fast and secure connection to its power supply.

Aufhängung aus geblasenem Glas in milchweißer Farbe, ausgestattet mit einer LED von 8W 900 Lumen, die intern mit einer Spule zur Rückgewinnung von überschüssigem Kabel (bis zu 2 Meter) und mit Anschluss über Buchse für eine schnelle und sichere Verbindung mit dem Sockel mit Stromversorgung ausgestattet ist.



**Module**  
**784/16 S 2m / 3m / 5m / 7m / 10m**  
 LED 8W 700mA CC 900lm 3000°K  
 upon request 2700°/4000° K  
 CE IP20  
 Net weight 710gr - Gross weight 1070gr  
 Volume m<sup>3</sup> 0,0084

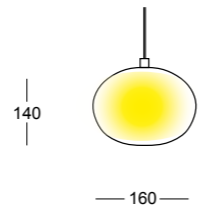

Module to be completed with  
 one of the bases on page 46.

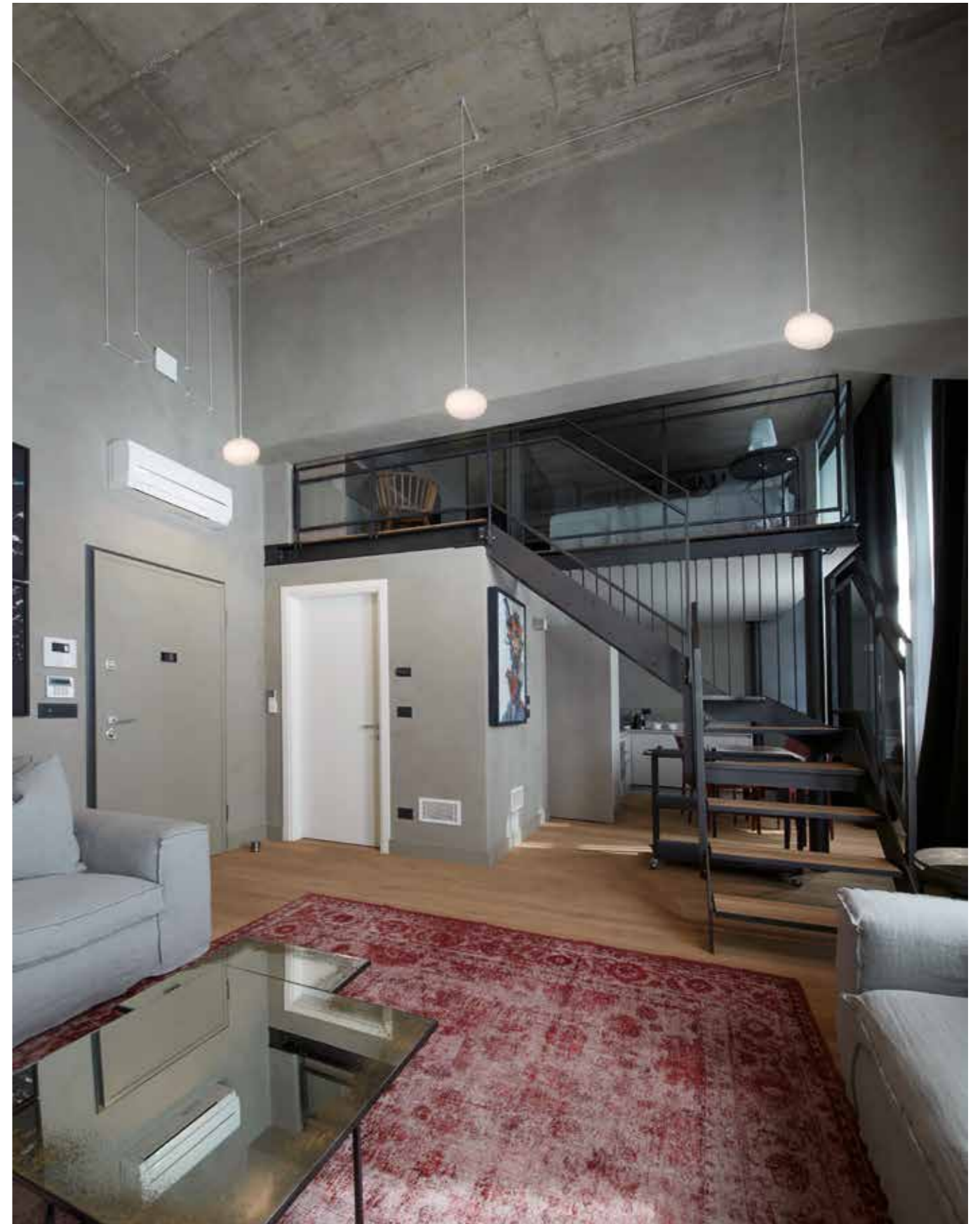



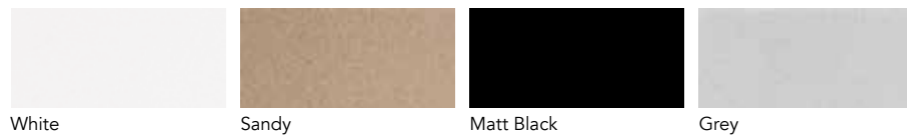

White

Sandy

Matt Black

Grey

# Stretch

design by C. Cattaneo

Sospensione in alluminio verniciato nelle colorazioni bianco, sabbia nero e grigio fornita di un led da 8w 900 lumen dotata internamente di un rocchetto per il recupero del cavo in eccesso (fino a 2 metri) e con collegamento tramite jack per un veloce e sicuro collegamento alla sua base con alimentatore.

Suspension in aluminium painted in white, sandy, black and grey colours, equipped with an 8w 900 lumens led, internally equipped with a spool for the recovery of the excess cable (up to 2 metres) and with connection via jack for a fast and safe connection to its power supply.

Aufhängung aus lackiertem Aluminium in den Farben Weiß, Sand, Schwarz und Grau, ausgestattet mit einer 8w 900 Lumen LED, innen ausgestattet mit einer Spule zur Rückgewinnung des überschüssigen Kabels (bis zu 2 Meter) und mit einem Klinkenanschluss für eine schnelle und sichere Verbindung zu seinem Sockel mit einem Netzteil.



**Module**

**776/1 S 2m / 3m / 5m / 7m / 10m**

LED 8W 700mA CC 900lm 3000°K

upon request 2700°/4000° K

CE IP20

Net weight 340gr - Gross weight 470gr

Volume m<sup>3</sup> 0,0010

Module to be completed with  
one of the bases on page 46

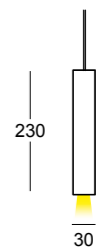

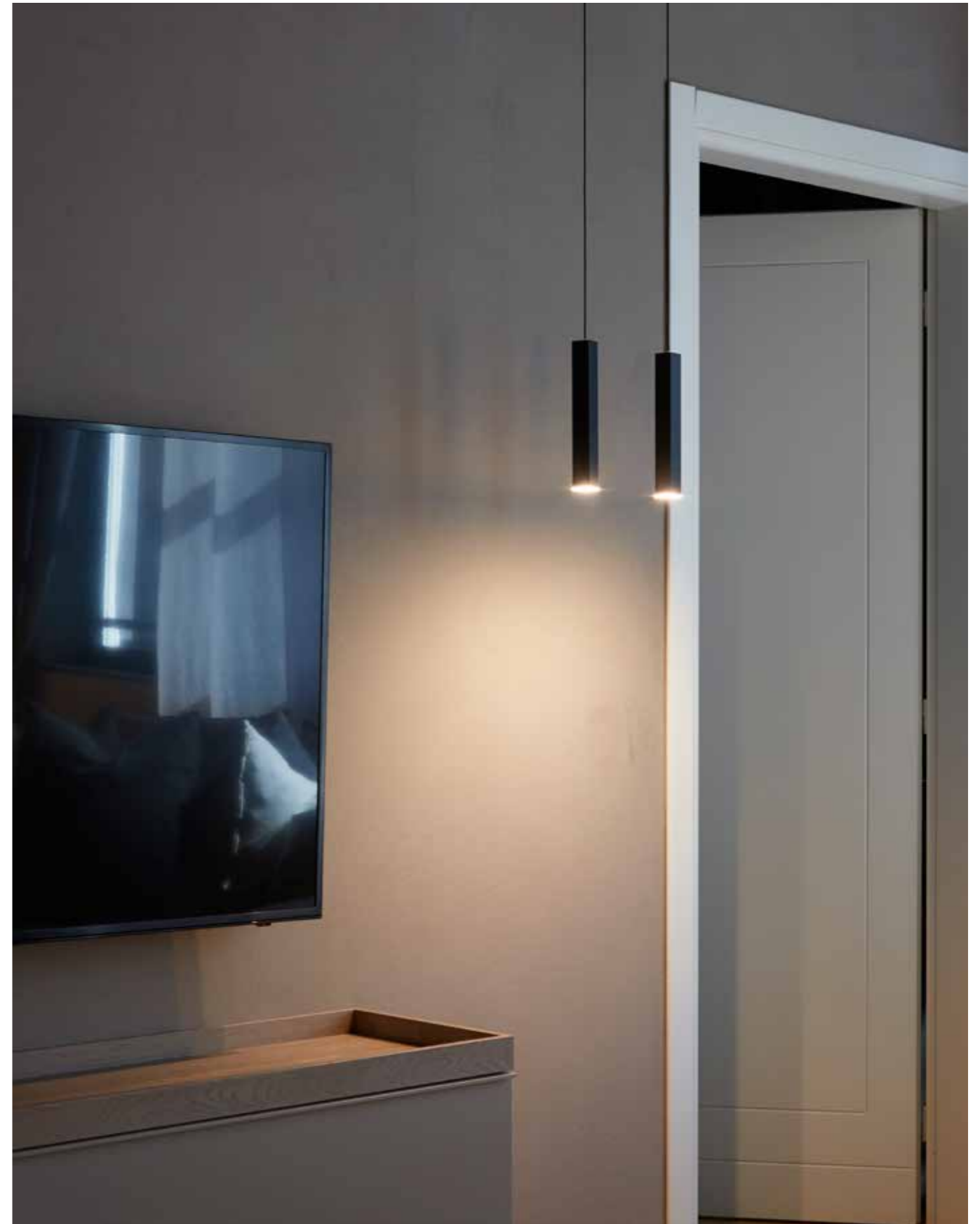



### Base for 1 module

**776/1 R**

Net weight 330gr  
Gross weight 480g  
Volume m<sup>3</sup> 0.0046

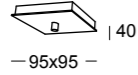

Until 1 modules



### Bases with side exits

**776/16 R**

Net weight 910gr  
Gross weight 1070gr  
Volume m<sup>3</sup> 0.0024

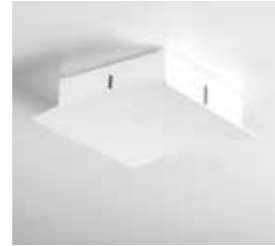

2 to 4 modules

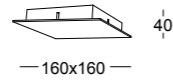

**776/20 R**

Net weight 1310gr  
Gross weight 1850gr  
Volume m<sup>3</sup> 0.0024

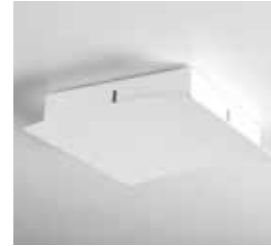

5 to 8 modules

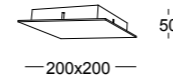

### Concealed spool for recovery of excess cable



### Cable Holder

**776/1RC**

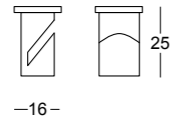

### Bases with side and central descent

**776/16TC**

Net weight 910gr  
Gross weight 1070gr  
Volume m<sup>3</sup> 0.0024



2 to 4 modules

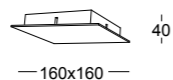

**776/20TC**

Net weight 1310gr  
Gross weight 1850gr  
Volume m<sup>3</sup> 0.0024

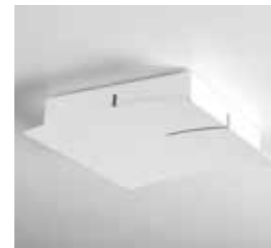

5 to 8 modules

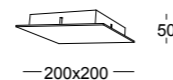

### Fast opening and jack connection for easy installation



### Recessed base

**776/1I**

Hole 30mm.

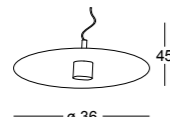

**RECESSED BASE**

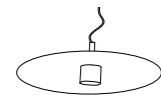

776/1 I

+



776/1 D

+

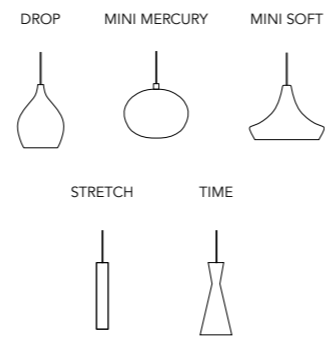

=

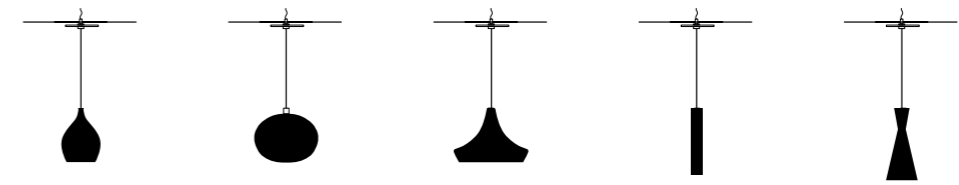

**BASE FOR 1 MODULE**



776/1R

+

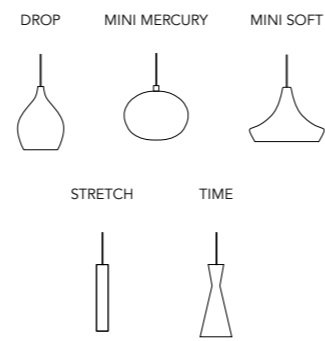

=

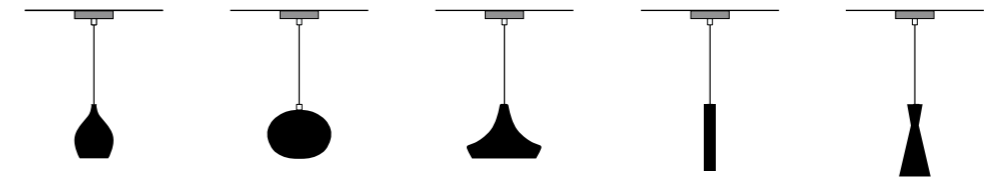

**BASE WITH SIDE EXITS**  
2 to 4 modules



776/16R

+

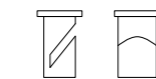

**CABLE HOLDER**  
max 4 cables

776/1RC

+

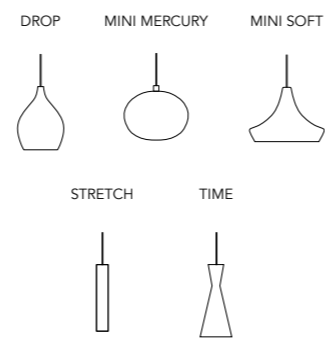

=

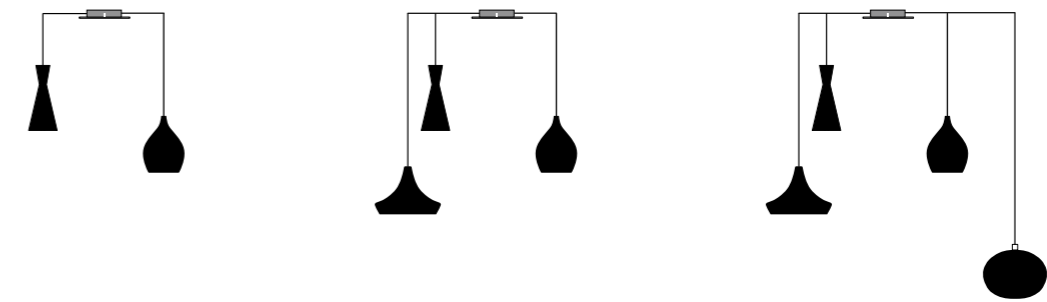

**BASE WITH SIDE EXITS**  
5 to 8 modules

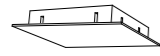

776/20R

+

**CABLE HOLDER**  
max 4 cables

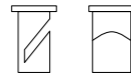

776/1RC

+

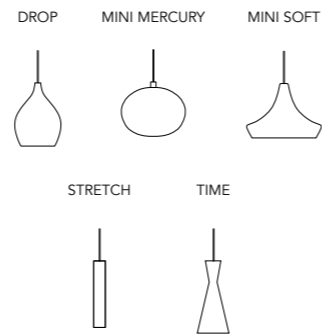

=

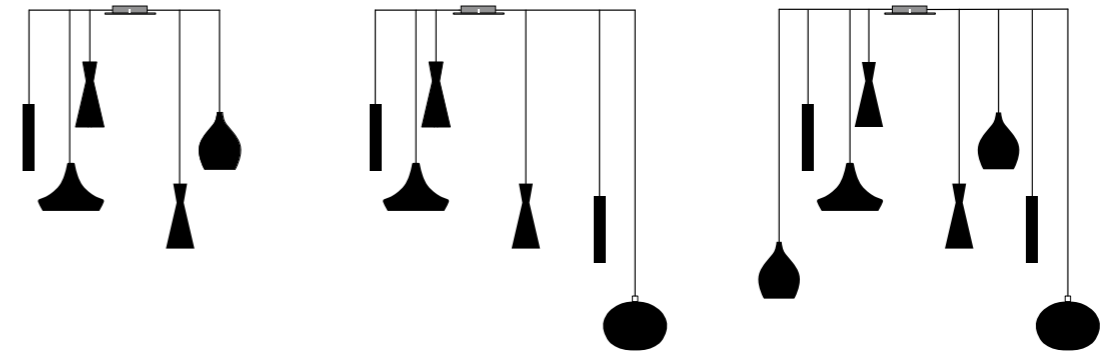

**BASE WITH SIDE AND CENTRAL DESCENT**  
2 to 4 modules



776/16TC

+

**CABLE HOLDER**  
max 4 cables

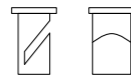

776/1RC

+

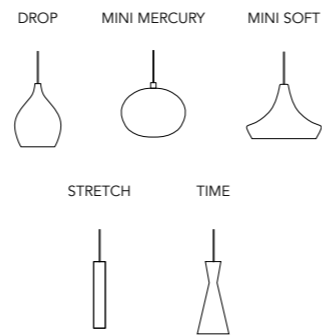

=

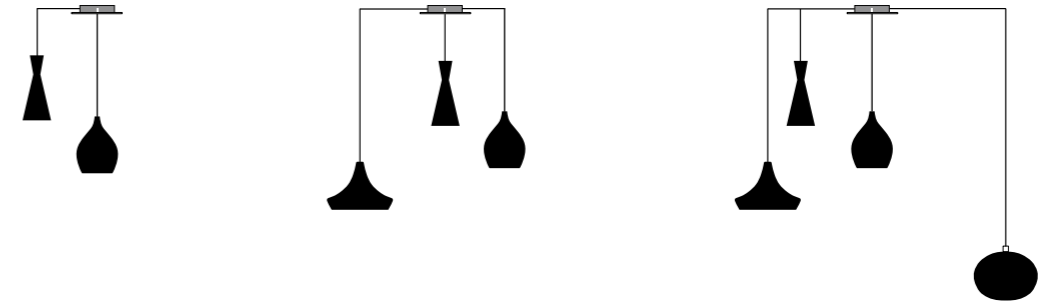

**BASE WITH SIDE AND CENTRAL DESCENT**  
5 to 8 modules



776/20TC

+

**CABLE HOLDER**  
max 4 cables

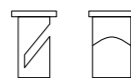

776/1RC

+

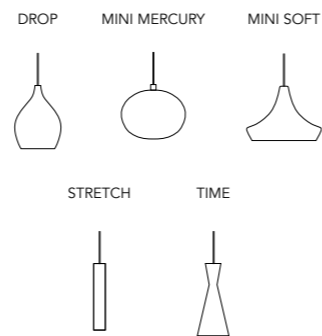

=

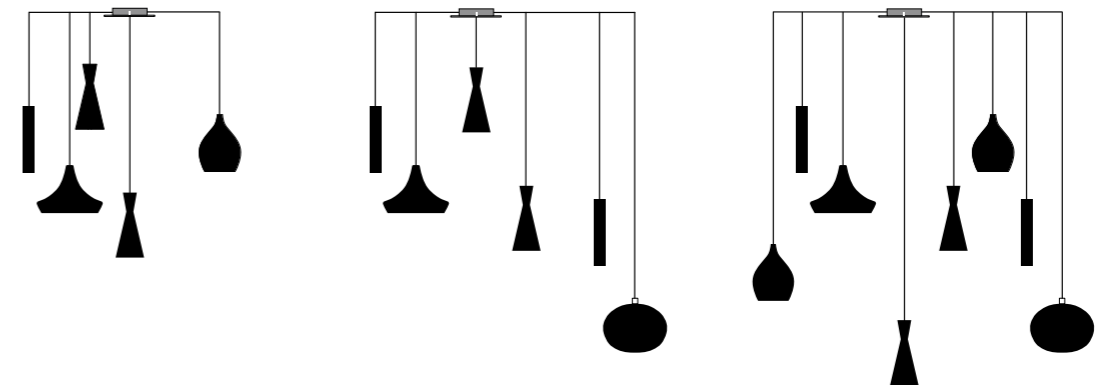



# Head System

design C. Cattaneo

Crea la tua luce: sistema a sospensione con diverse forme compatibili. Incluso 3 lenti con differenti angolazioni, o diffusori per creare i tuoi punti di accento o la tua atmosfera.

Create your light: suspended system with several shapes, compatible with one another. To let you create your main lighting points or your atmosphere, three lens with different angles or diffusers are included.

Erstellen Sie Ihre eigene Lichtquelle. Pendelsysteme mit verschiedenen kompakten Formen, inklusive 3 Linsen mit unterschiedlichen Strahlungswinkeln, sowie Lichtpunkte aus Glas können der Atmosphäre neue Akzente geben.

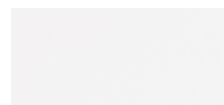

White



Sandy



Matt Black



Grey

# Nuts



design by C. Cattaneo

Sospensione in alluminio verniciato nelle colorazioni bianco, sabbia, nero e grigio fornita di un led da 14w 1500 lumen dotata internamente di un rocchetto per il recupero del cavo in eccesso (fino a 2 metri) e di un appiglio esterno per potere inclinare la lampada con un gioco di cavi ed orientare la luce dove serve con collegamento tramite jack per un veloce e sicuro collegamento alla sua base con alimentatore.

Suspension in aluminium painted in white, sandy, black and grey colours, equipped with a 14W 1500 lumens led equipped internally with a spool for the recovery of the excess cable (up to 2 metres) and with an external hook to be able to tilt the body of the lamp with a play of cables and orient the light where it is needed. Jack connection for a quick and safe connection to its power supply.

Aufhängung aus lackiertem Aluminium in den Farben Weiß, Sand, Schwarz und Grau, ausgestattet mit einer 14 W 1500 Lumen LED, die intern mit einer Spule zur Rückgewinnung des überschüssigen Kabels (bis zu 2 Meter) und mit einem externen Handgriff ausgestattet ist, um die Lampe mit einem Kabelspiel kippen und das Licht dort ausrichten zu können, wo es benötigt wird, mit einem Klinkenanschluss für eine schnelle und sichere Verbindung zu ihrem Sockel mit einem Netzteil.



**Module**  
**780/14 S 3m / 5m / 7m / 10m / 15m**  
 LED 14W 700mA CC 1500lm 3000°K  
 CE  IP20  
 Net weight 665gr - Gross weight 1087gr  
 Volume m<sup>3</sup> 0,0084  
 0 ~ 10VDC, or 10V PWM signal  
 push or dali dimming upon request

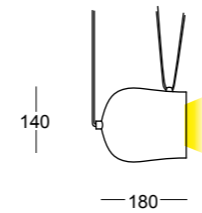

Module to be completed with  
 one of the bases on page 68



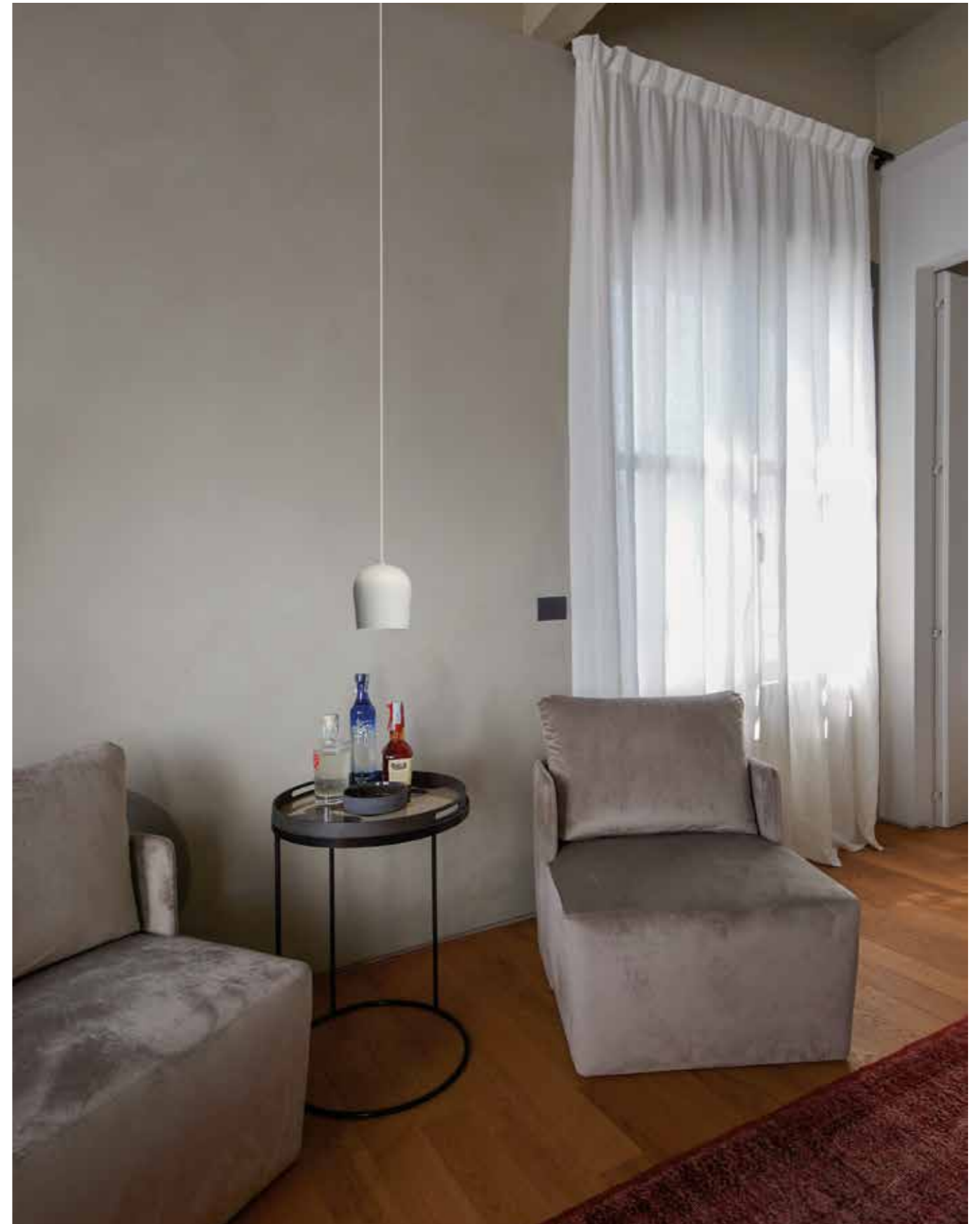
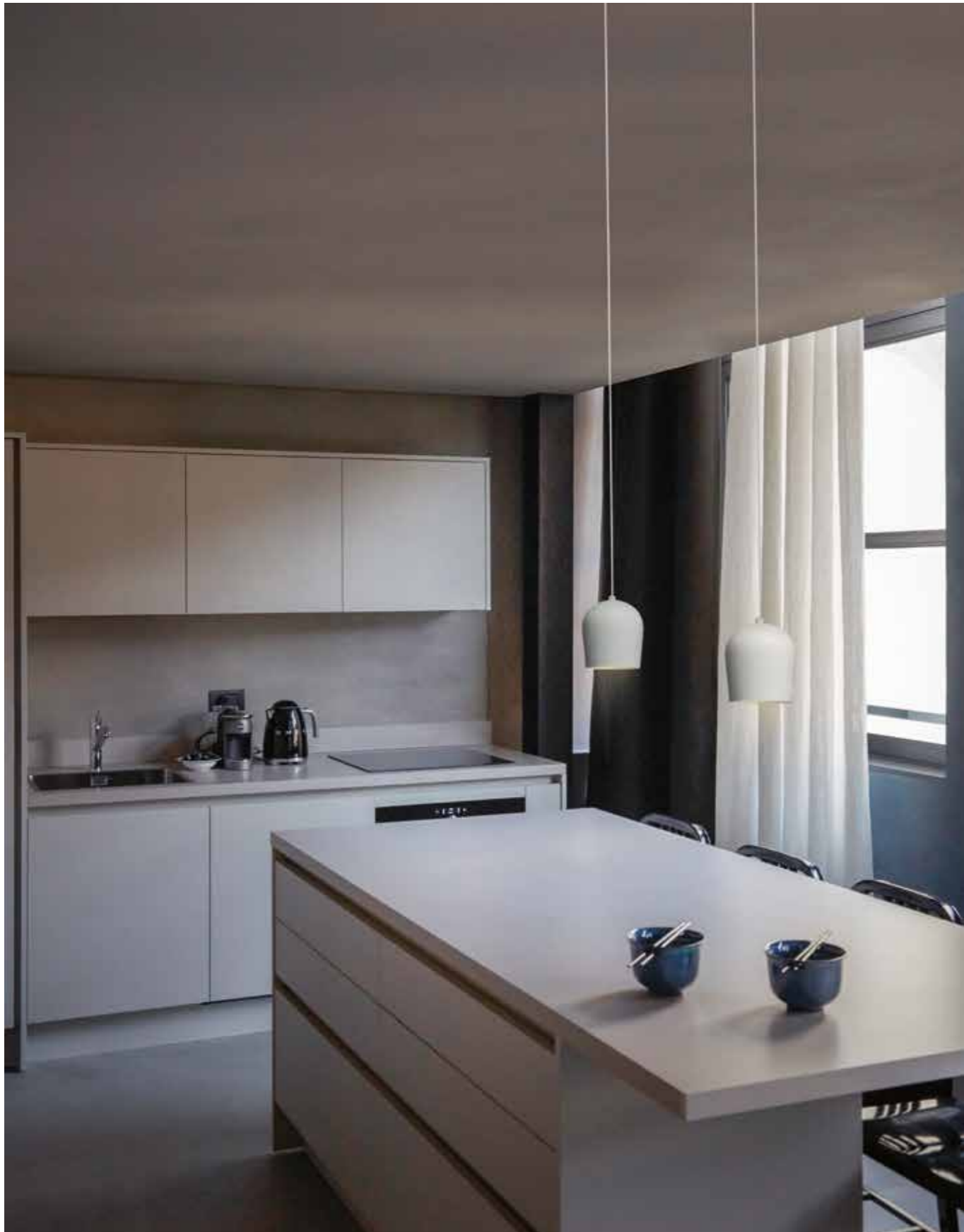

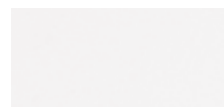

White



Sandy



Matt Black

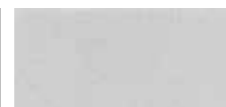

Grey

# Ball

design by C. Cattaneo

Sospensione in alluminio verniciato nelle colorazioni bianco, sabbia, nero e grigio fornita di un led da 14w 1500 lumen dotata internamente di un rocchetto per il recupero del cavo in eccesso (fino a 2 metri) e di un appiglio esterno per potere inclinare la lampada con un gioco di cavi ed orientare la luce dove serve con collegamento tramite jack per un veloce e sicuro collegamento alla sua base con alimentatore.

Suspension in aluminium painted in white, sandy, black and grey colours equipped with a 14W 1500 lumens led, equipped internally with a spool for the recovery of the excess cable (up to 2 metres) and with an external hook to be able to tilt the body of the lamp with a play of cables and orient the light where it is needed. Jack connection for a quick and safe connection to its power supply.

Aufhängung aus lackiertem Aluminium in den Farben Weiß, Sand, Schwarz und Grau, ausgestattet mit einer 14 W 1500 Lumen LED, die intern mit einer Spule zur Rückgewinnung des überschüssigen Kabels (bis zu 2 Meter) und mit einem externen Handgriff ausgestattet ist, um die Lampe mit einem Kabelspiel kippen und das Licht dort ausrichten zu können, wo es benötigt wird, mit einem Klinkenanschluss für eine schnelle und sichere Verbindung zu ihrem Sockel mit einem Netzteil.





**Module**  
**865/18 S 3m / 5m / 7m / 10m / 15m**  
LED 14W 700mA CC 1500lm 3000°K  
CE IP20  
Net weight 700gr - Gross weight 1150gr  
Volume m<sup>3</sup> 0,0084  
Dimmable 0-10VDC, or 10V PWM signal  
push or dali dimming upon request

Module to be completed with  
one of the bases on page 68

Head System | Ball

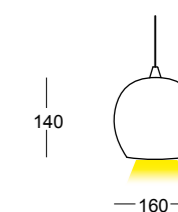

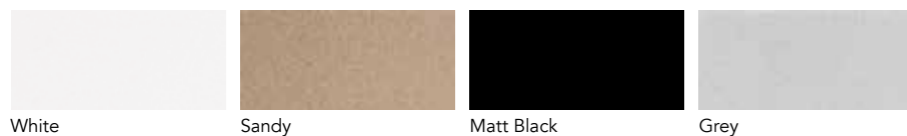

White

Sandy

Matt Black

Grey

# Cone

design by C. Cattaneo

Sospensione in alluminio verniciato nelle colorazioni bianco, sabbia, nero e grigio fornita di un led da 14w 1500 lumen dotata internamente di un rocchetto per il recupero del cavo in eccesso (fino a 2 metri) e di un appiglio esterno per potere inclinare la lampada con un gioco di cavi ed orientare la luce dove serve con collegamento tramite jack per un veloce e sicuro collegamento alla sua base con alimentatore.

Suspension in aluminium painted in white, sandy, black and grey colours equipped with a 14W 1500 lumens led equipped internally with a spool for the recovery of the excess cable (up to 2 metres) and with an external hook to be able to tilt the lamp with a play of cables and orient the light where it is needed. Jack connection for a quick and safe connection to its power supply.

Aufhängung aus lackiertem Aluminium in den Farben Weiß, Sand, Schwarz und Grau, ausgestattet mit einer 14 W 1500 Lumen LED, die intern mit einer Spule zur Rückgewinnung des überschüssigen Kabels (bis zu 2 Meter) und mit einem externen Handgriff ausgestattet ist, um die Lampe mit einem Kabelspiel kippen und das Licht dort ausrichten zu können, wo es benötigt wird, mit einem Klinkenanschluss für eine schnelle und sichere Verbindung zu ihrem Sockel mit einem Netzteil.



**Module**

867/12 S 3m / 5m / 7m / 10m / 15m

LED 14W 700mA CC 1500lm 3000°K

CE IP20

Net weight 570gr - Gross weight 870gr

Volume m<sup>3</sup> 0,0069

Dimmable 0 ~ 10VDC, or 10V PWM signal

push or dali dimming upon request

Module to be completed with  
one of the bases on page 68

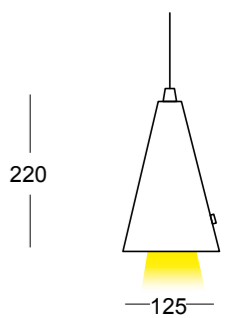

### Base for 1 module

#### 780/1 R

Net weight 910gr  
Gross weight 1070gr  
Volume m<sup>3</sup> 0.0024

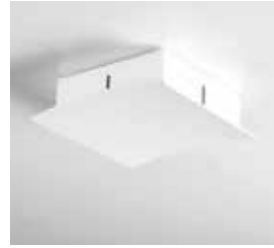

Until 1 module



### Bases with side exits

#### 780/16 R

Net weight 1140gr  
Gross weight 1293gr  
Volume m<sup>3</sup> 0.0024



1 to 3 modules

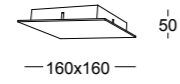

#### 780/20 R

Net weight 2000gr  
Gross weight 2600gr  
Volume m<sup>3</sup> 0.0021

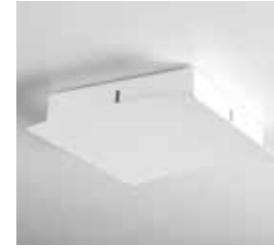

2 to 6 modules

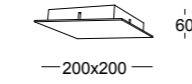

### Cable Holder

#### 776/1 RC

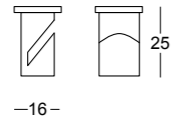
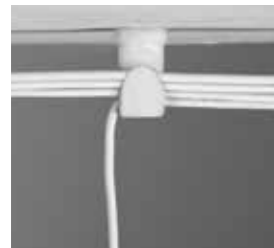

### Bases with side and central descent

#### 780/16 TC

Net weight 1140gr  
Gross weight 1293gr  
Volume m<sup>3</sup> 0.00253



1 to 3 modules

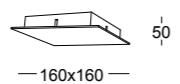

#### 780/20 TC

Net weight 2000gr  
Gross weight 2600gr  
Volume m<sup>3</sup> 0.0021

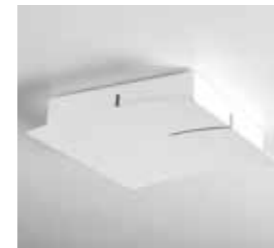

2 to 6 modules

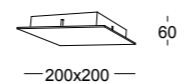

### Head System Kit



120° without lens



Support for lens



28° lens



37° lens



50° lens



Concealed spool for recovery of excess cable

**BASE FOR 1 MODULE**



780/1R

+

**CABLE HOLDER**  
max 4 cables

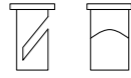

776/1RC

+

BALL



CONE



NUTS



=

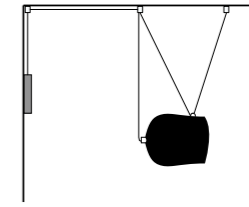
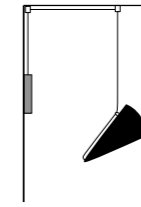
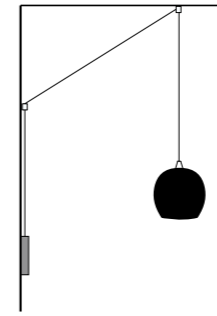

**BASE WITH SIDE EXITS**  
up to 3 modules



780/16R

+

**CABLE HOLDER**  
max 4 cables

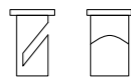

776/1RC

+

BALL



CONE



NUTS



=

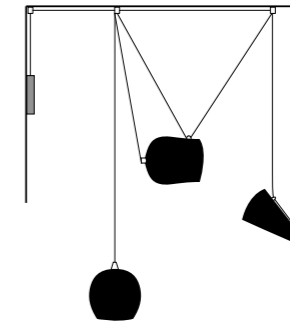
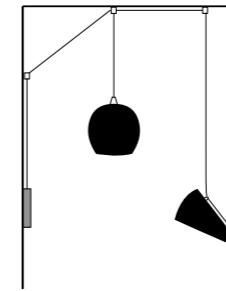

**BASE WITH SIDE EXITS**  
4 to 6 modules



780/20R

+

**CABLE HOLDER**  
max 4 cables



776/1RC

+

BALL



CONE



NUTS



=

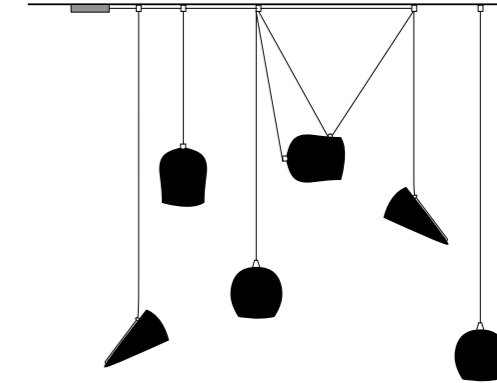
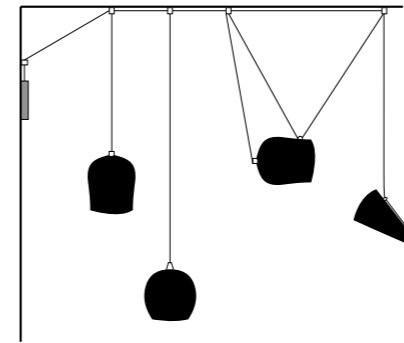

**BASE WITH SIDE  
AND CENTRAL DESCENT**  
up to 3 modules



780/16TC

+

**CABLE HOLDER**  
max 4 cables

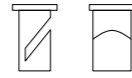

776/1RC

+

BALL



CONE



NUTS



=

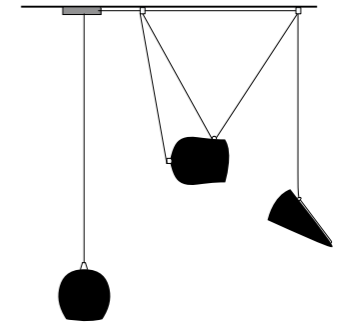
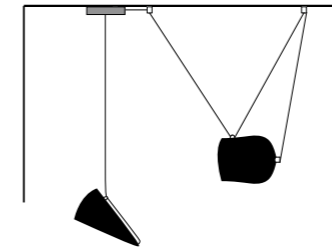

**BASE WITH SIDE  
AND CENTRAL DESCENT**  
4 to 6 modules



780/20TC

+

**CABLE HOLDER**  
max 4 cables

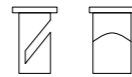

776/1RC

+

BALL



CONE



NUTS



=

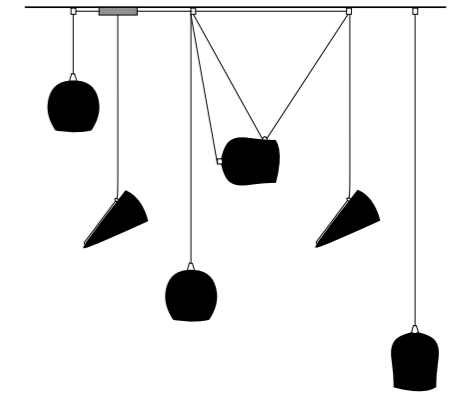
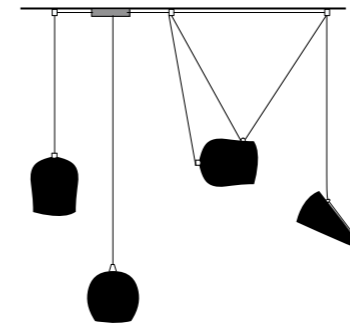

# Line System

design C. Cattaneo

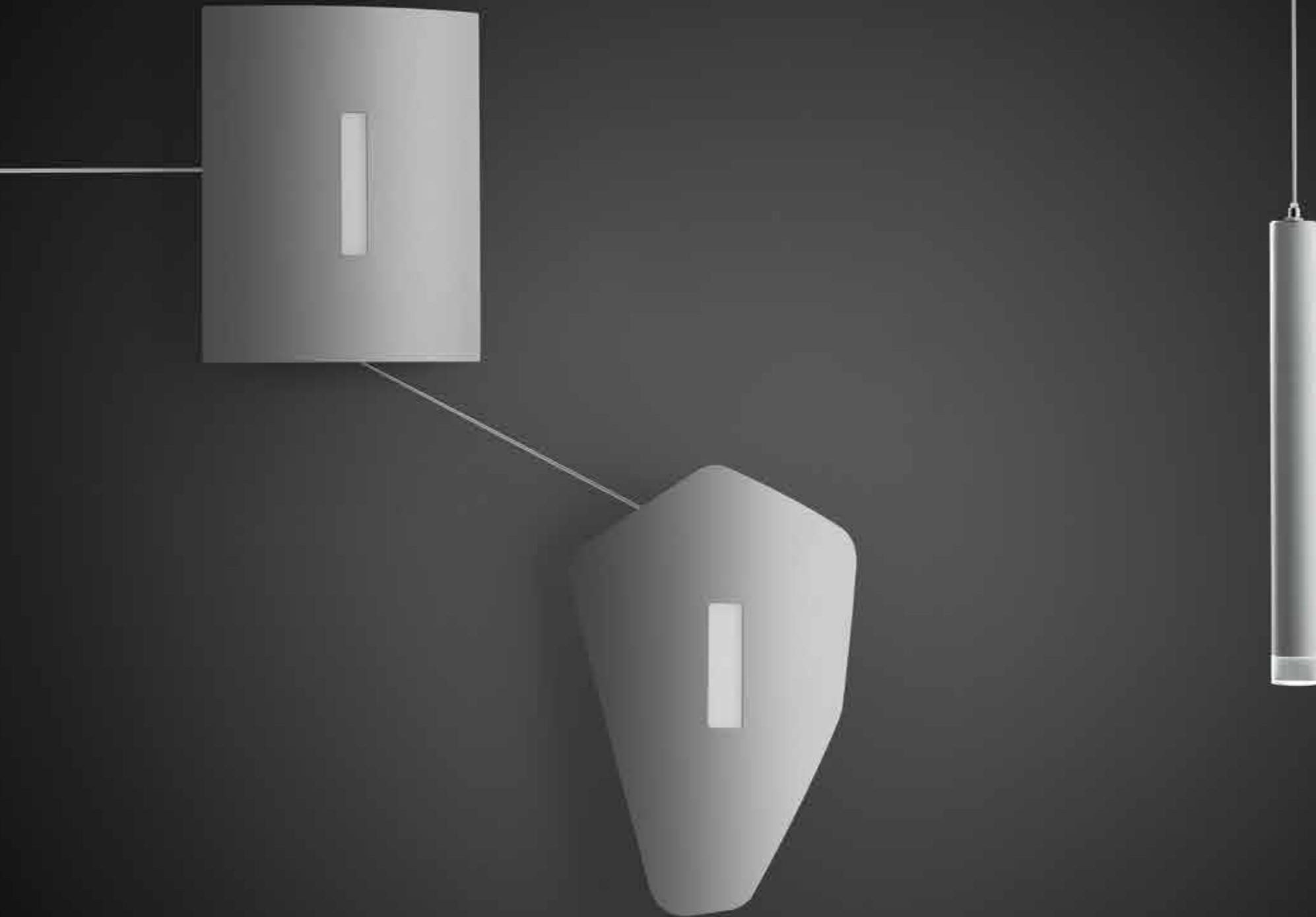

Scatena la tua fantasia: sistema da parete, plafone e sospensione, con un unico punto luce puoi dar sfogo alla tua creatività.

Unleash your fantasy: wall, ceiling and suspension system. With a sole light source you can vent your creativity.

Entfalten Sie Ihre Phantasie: systeme für Wand-, Decke-, und Pendelleuchten, hier können Sie Ihrer Kreativität mit einer einzigen Lichtquelle freien Lauf lassen.

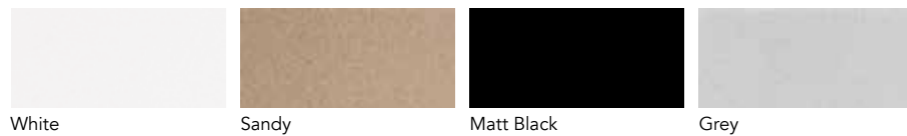
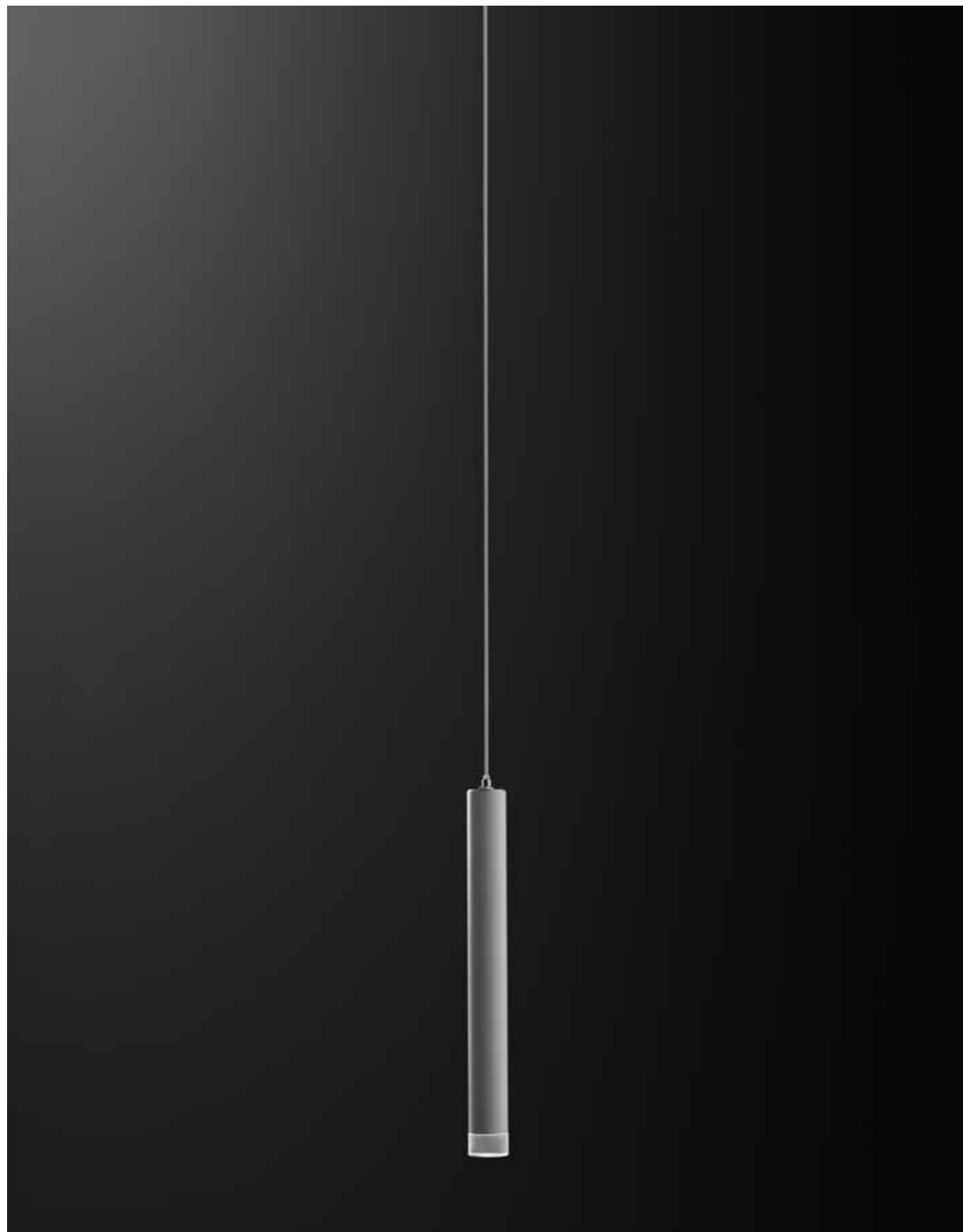

White

Sandy

Matt Black

Grey

# E.R.

design by C Cattaneo

Sospensione in alluminio verniciato nelle colorazioni bianco, sabbia, nero e grigio fornita di un led da 6w 900 lumen dotata internamente di un rocchetto per il recupero del cavo in eccesso (fino a 2 metri) e con collegamento tramite jack per un veloce e sicuro collegamento alla sua base con alimentatore.

Suspension in aluminium painted in white, sandy, black and grey colours, equipped with a 6W 900 lumens led, internally equipped with a spool for the recovery of the excess cable (up to 2 metres) and with connection via jack for a fast and secure connection to its power supply.

Aufhängung aus lackiertem Aluminium in den Farben Weiß, Sand, Schwarz und Grau, ausgestattet mit einer 6W 900 Lumen LED, innen ausgestattet mit einer Spule zur Rückgewinnung des überschüssigen Kabels (bis zu 2 Meter) und mit Klinkensteckeranschluss für eine schnelle und sichere Verbindung zu seinem Sockel mit einem Netzteil.





**Module**

850/1 S 2m / 3m / 5m / 7m / 10m

LED 1x6W - 24V Dc - 900lm 3000°K

upon request 2700°/4000°K

CE IP20

Net weight 265gr - Gross weight 480gr

Volume m<sup>3</sup> 0,009

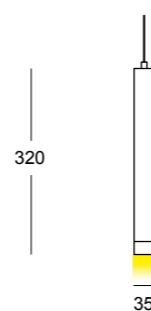

Module to be completed with one of the bases on page 90





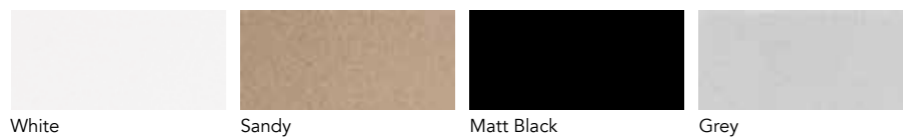
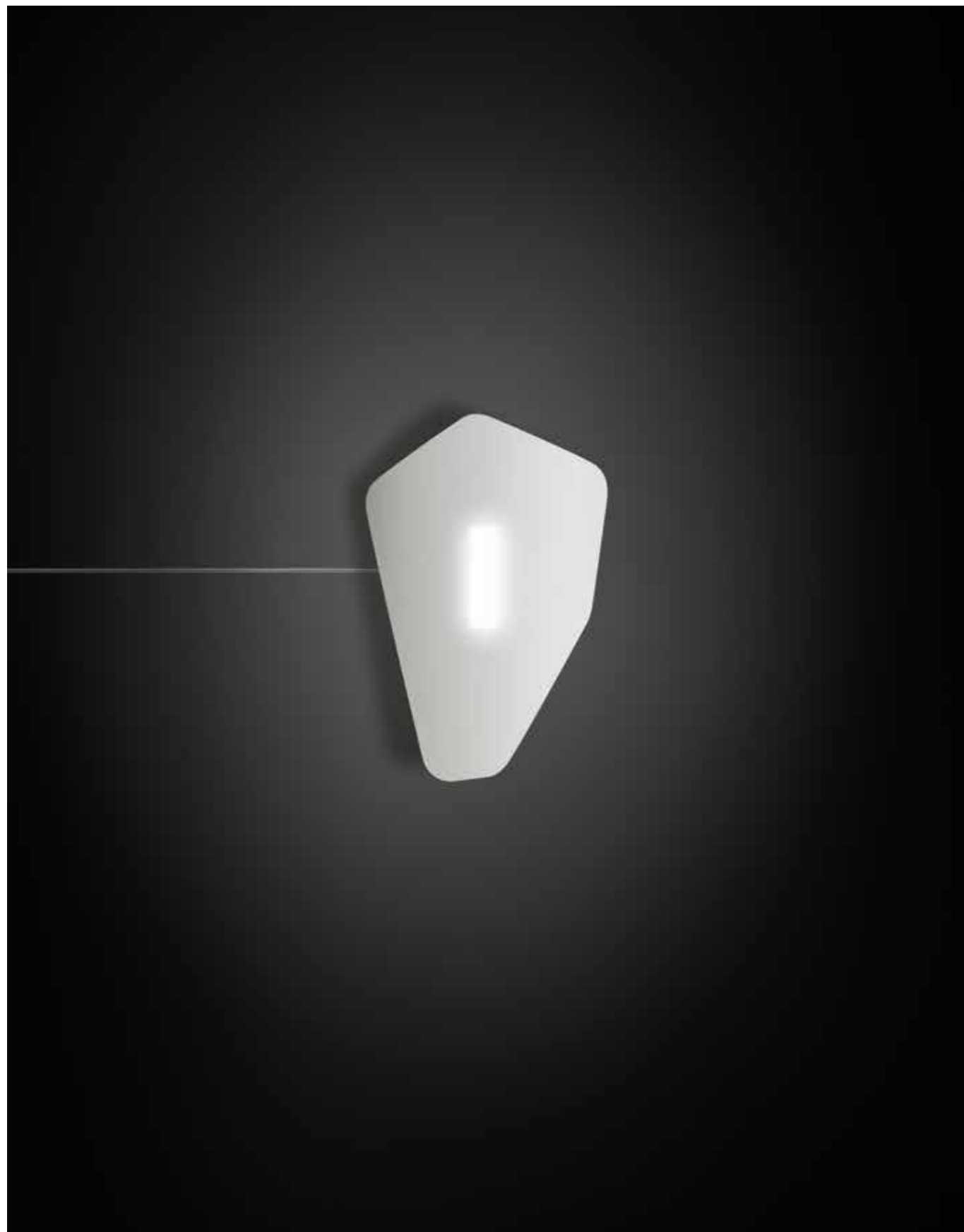

White

Sandy

Matt Black

Grey

# Stone

design by C. Cattaneo

Lampada da parete/plafone in metallo verniciato nelle colorazioni bianco, sabbia, nero e grigio fornita di un led da 6w 900 lumen dotata internamente di un rocchetto per il recupero del cavo in eccesso (fino a 2 metri) e con collegamento tramite jack per un veloce e sicuro collegamento alla sua base con alimentatore.

Wall/ceiling lamp in metal painted in white, sandy, black and grey colours, equipped with a 6W 900 lumens led, internally equipped with a spool for the recovery of excess cable (up to 2 metres) and with connection via jack for a fast and secure connection to its power supply.

Wandlampe/Deckenleuchte aus lackiertem Metall in den Farben weiß, sand, schwarz und grau mit einem LED 6w 900 Lumen, das innen mit einer Spule zur Rückgewinnung von Kabelüberschüssen (bis zu 2 Meter) und mit Anschluss über Buchse für eine schnelle und sichere Verbindung zu seinem Sockel mit Netzteil ausgestattet ist.

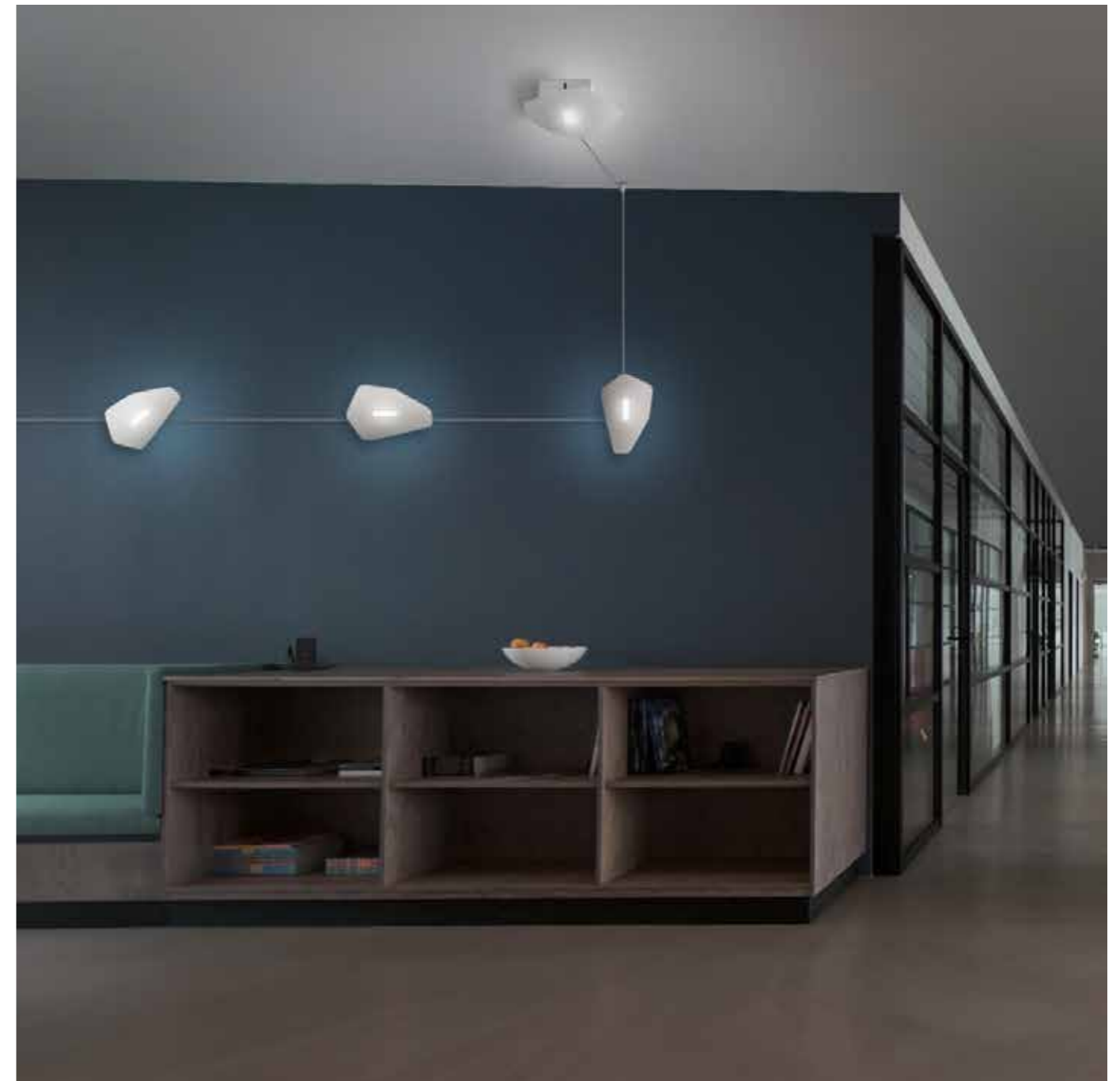
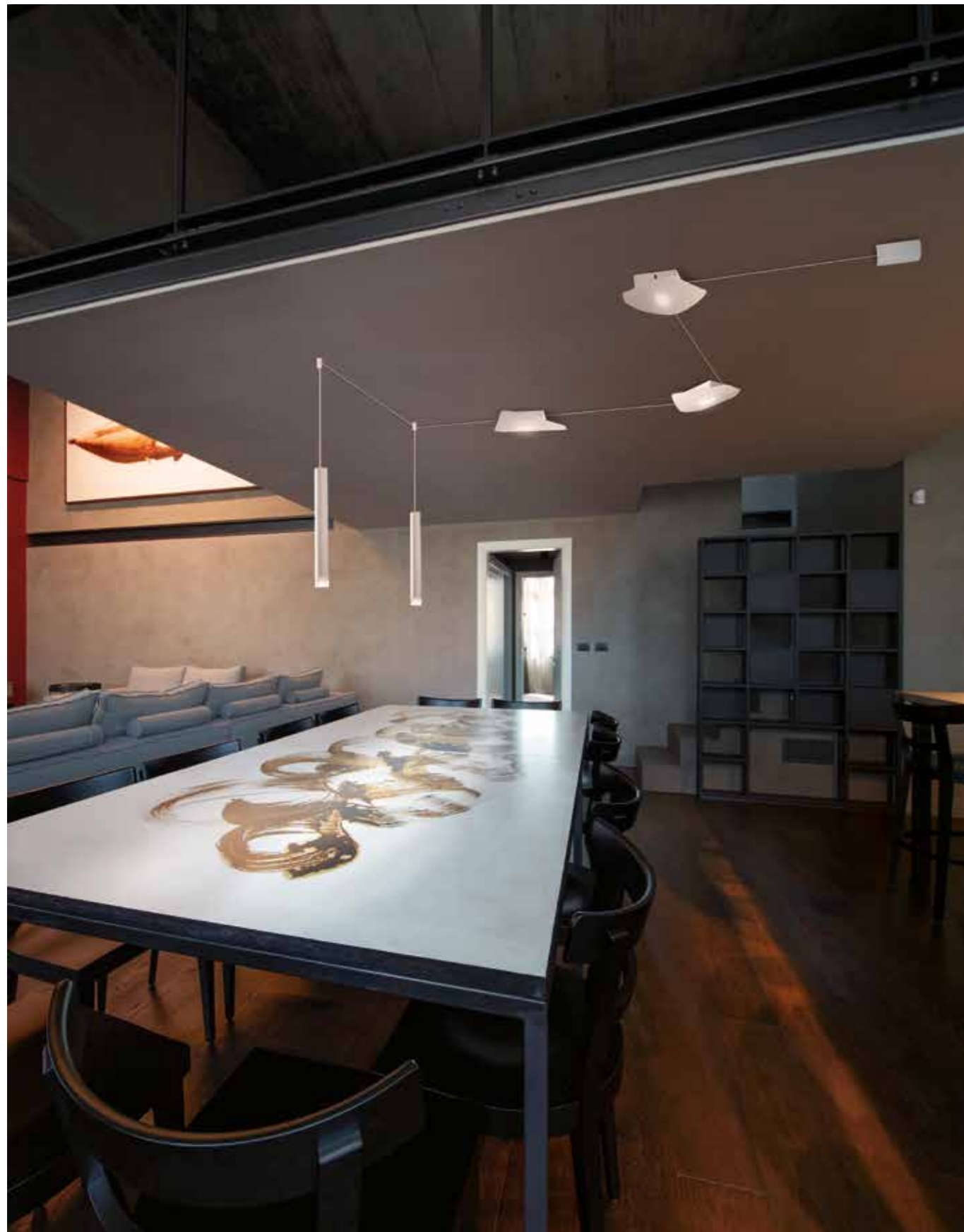

**Module**

**853/1 P 2m/3m/5m/7m/10m**

LED 1x6W - 24V Dc - 900lm 3000°K

upon request 2700°/4000°K

CE IP20

Net weight 758gr - Gross weight 806gr

Volume m<sup>3</sup> 0,0046

Module to be completed with  
one of the bases on page 90

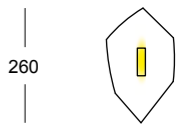

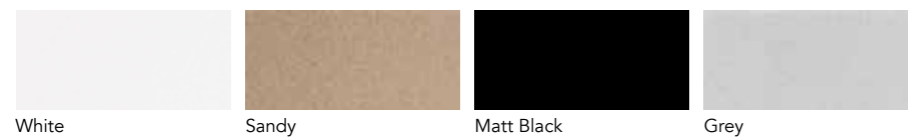
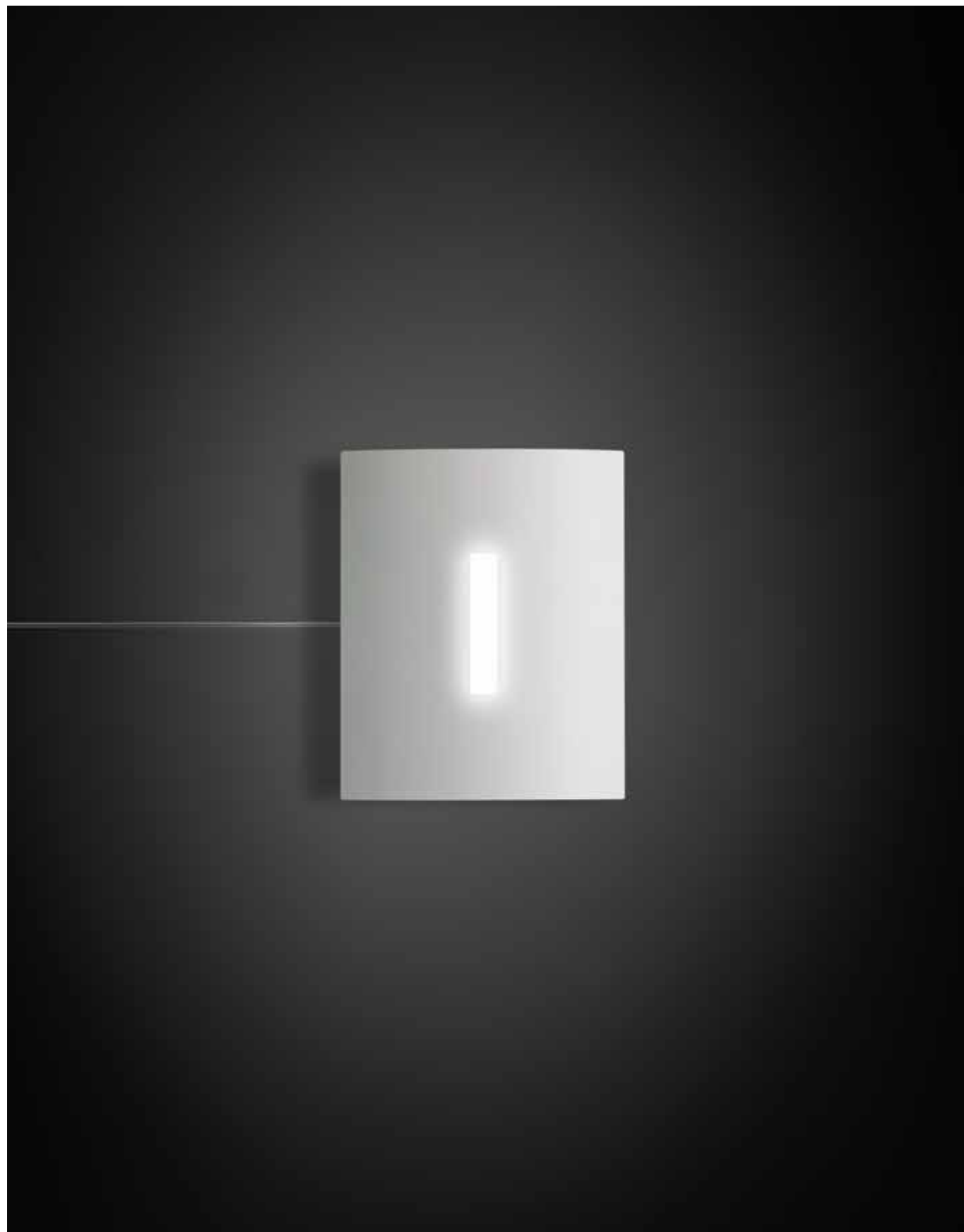

White

Sandy

Matt Black

Grey

# Iron

design by C. Cattaneo

Lampada da parete/plafone in metallo verniciato nelle colorazioni bianco, sabbia, nero e grigio fornita di un led da 6w 900 lumen dotata internamente di un rocchetto per il recupero del cavo in eccesso (fino a 2 metri) e con collegamento tramite jack per un veloce e sicuro collegamento alla sua base con alimentatore.

Wall/ceiling lamp in metal painted in white, sandy, black and grey colour equipped with a 6W 900 lumens led, internally equipped with a spool for the recovery of excess cable (up to 2 metres) and with connection via jack for a fast and secure connection to its power supply

Wandlampe/Deckenleuchte aus lackiertem Metall in den Farben weiß, sand, schwarz und grau mit einem LED 6w 900 Lumen, das innen mit einer Spule zur Rückgewinnung von Kabelüberschüssen (bis zu 2 Meter) und mit Anschluss über Buchse für eine schnelle und sichere Verbindung zu seinem Sockel mit Netzteil ausgestattet ist.

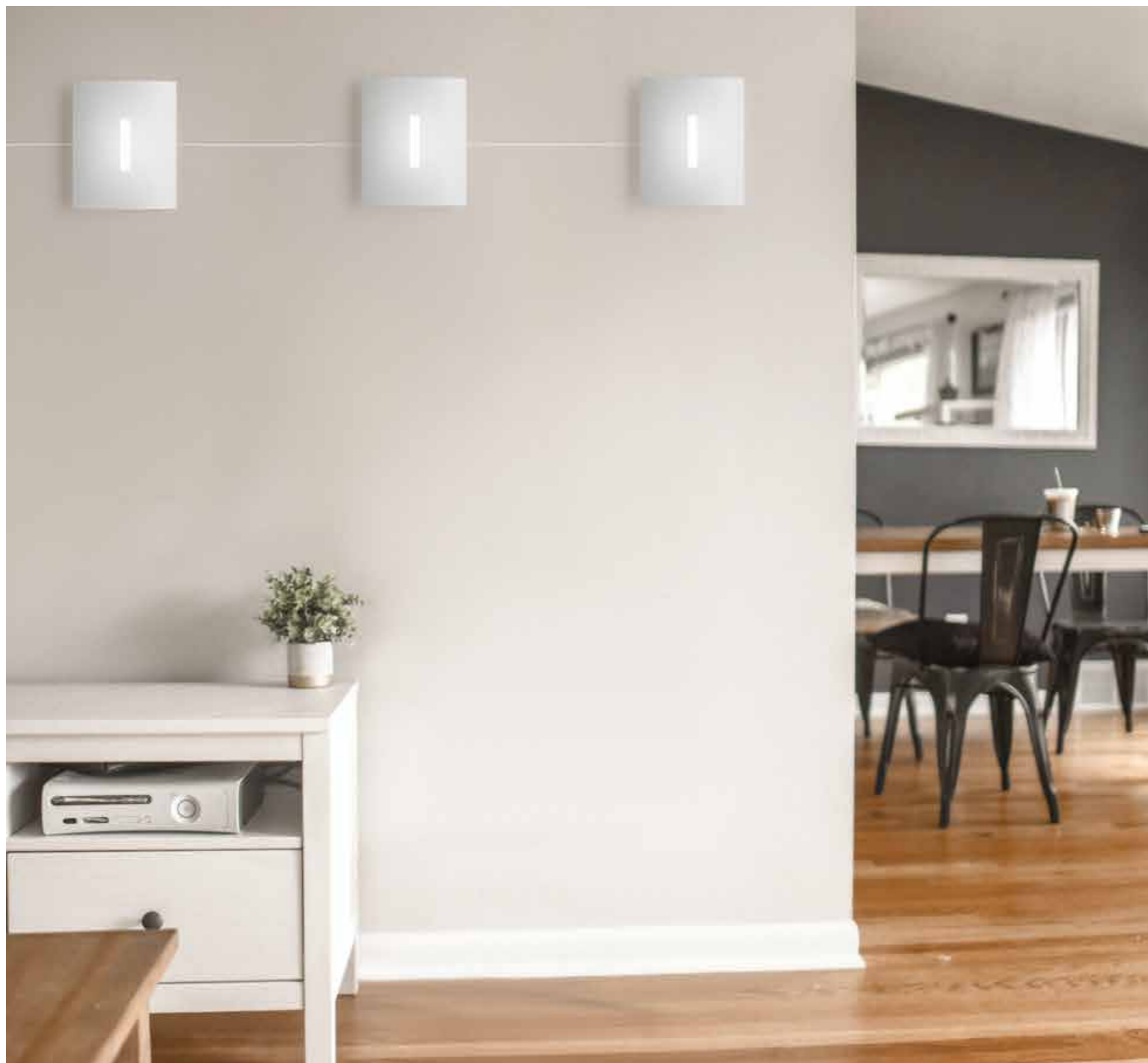

**Module**

**855/1 P 2m / 3m / 5m / 7m / 10m**

LED 1x6W - 24V Dc - 900lm 3000°K

upon request 2700°/4000°K

CE IP20

Net weight 758gr - Gross weight 806gr

Volume m<sup>3</sup> 0,0046

Module to be completed with  
one of the bases on page 90



—180—

**Cable Holder**

776/1RC

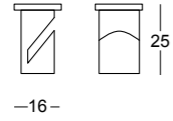
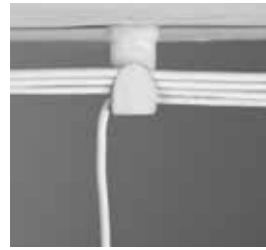

**Bases with side exits**

**856/16 R**

Net weight 373gr  
Gross weight 526gr  
Volume m<sup>3</sup> 0.0046



up to 6 modules

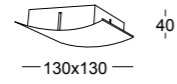

**856/20 R**

Net weight 997gr  
Gross weight 1252gr  
Volume m<sup>3</sup> 0.009



up to 16 modules

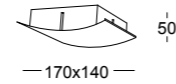

**Bases with side and central descent**

**856/16 TC**

Net weight 373gr  
Gross weight 526gr  
Volume m<sup>3</sup> 0.0046



up to 6 modules

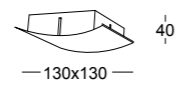

**856/20 TC**

Net weight 997gr  
Gross weight 1252gr  
Volume m<sup>3</sup> 0.009



up to 16 modules

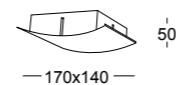

**Fast opening and jack connection for a quick installation.**



**Concealed spool for recovery of excess cable**



**Concealed spool for recovery of excess cable**



**BASES WITH SIDE AND CENTRAL DESCENT**  
up to 6 modules

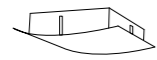

856/16R

+

**CABLE HOLDER**  
max 4 cables

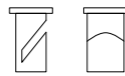

776/1RC

+

E.R.



IRON



STONE



=

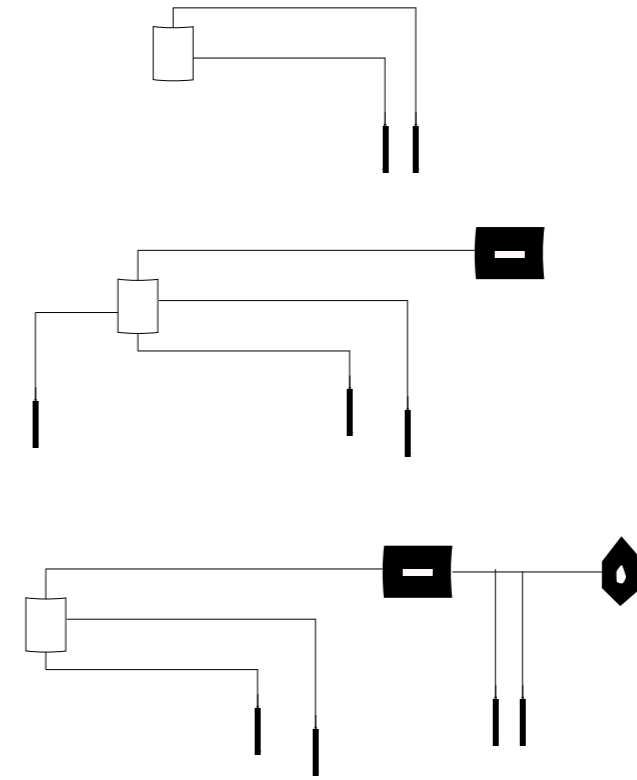

**BASES WITH SIDE AND CENTRAL DESCENT**  
8 modules + 8

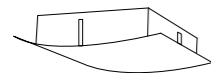

856/20R

+

**CABLE HOLDER**  
max 4 cables

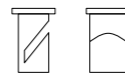

776/1RC

+

E.R.



IRON



STONE



=

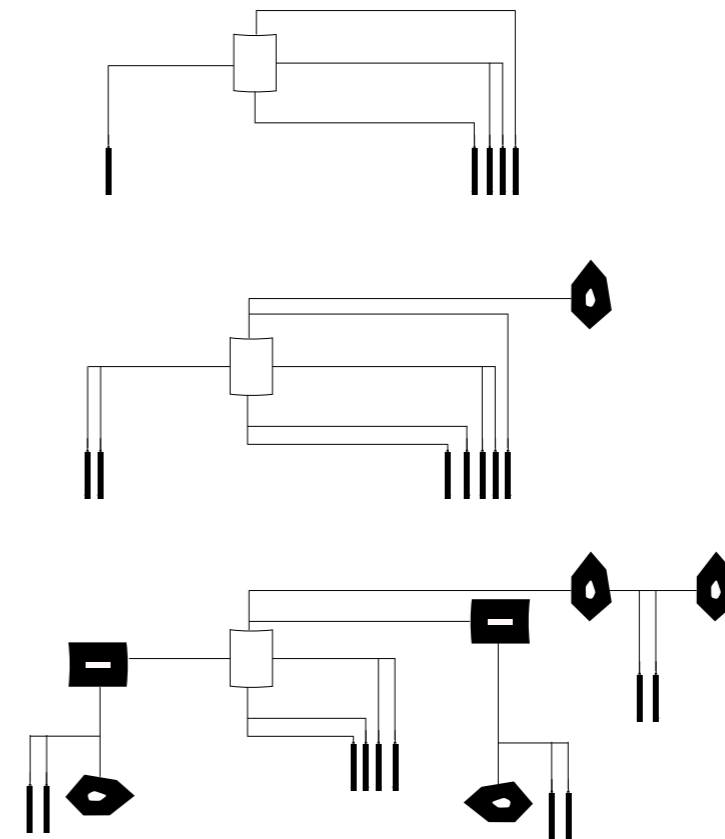



**BASE WITH SIDE AND  
CENTRAL DESCENT**  
up to 6 modules

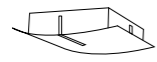

856/16TC

+

**CABLE HOLDER**  
max 4 cables

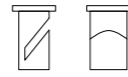

776/1RC

+

E.R.



IRON



STONE



=

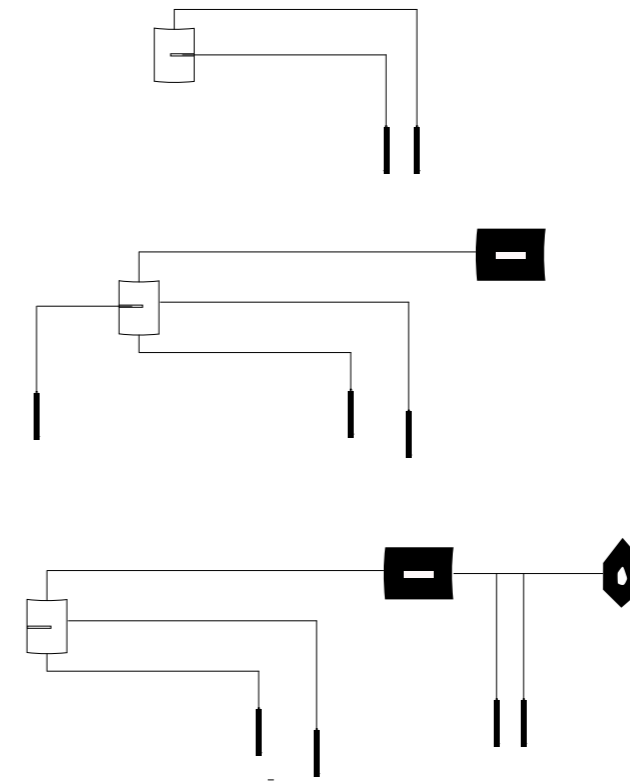

**BASE WITH SIDE AND  
CENTRAL DESCENT**  
8 modules + 8

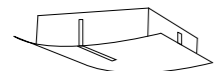

856/20TC

+

**CABLE HOLDER**  
max 4 cables

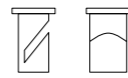

776/1RC

+

E.R.



IRON



STONE



=

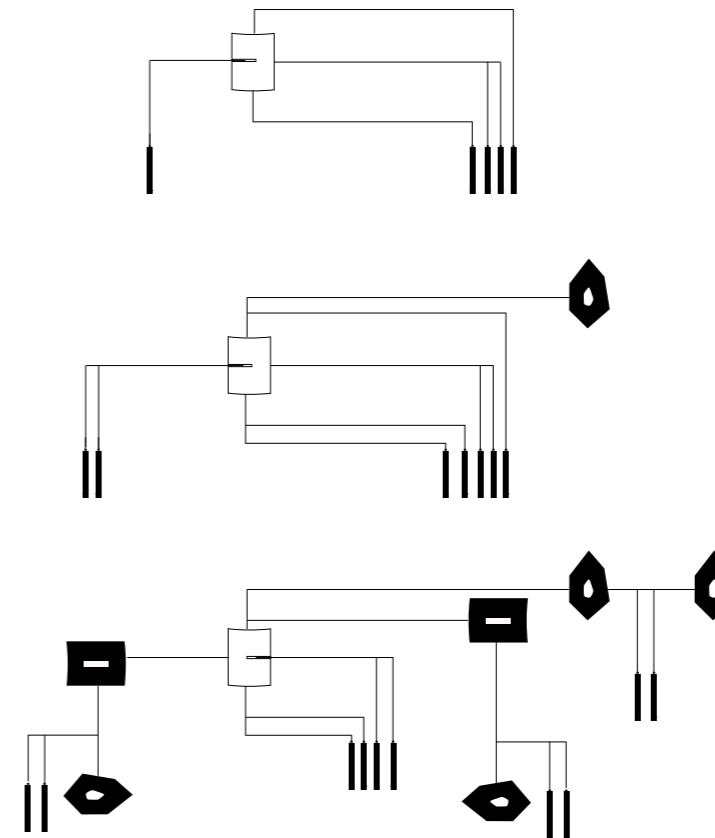



# Waterfalls

design by C. Cattaneo

Serie di moduli led disponibili singolarmente per poter personalizzare la propria lampada. Adatta in ambienti moderni che vogliono valorizzare "l'oggetto luce". E' composta da diffusori in vetro termoresistenti montate su varie strutture a scelta.

Series of led modules that can be purchased individually to customise your own lamp. Suitable for modern interiors in which light is emphasized as an object. It consists of heat-resistant glass diffusers to be fitted on a wide range of bases.

Eine Serie auch einzeln erhaeltlicher Led Modulen geben die Moeglichkeit, die eigene Lampe nach eigener persoenlicher Vorstellung als Lichtobjekt zu gestalten. Ist hergestellt aus hitzebestaendigen Glas, montiert auf diversen Strukturen, welche ausgewaehlt werden koennen.



Transparent Satin



**Customised lamp composed of:**

B151/29 + 6 pcs M151 + D151/7

CE IP20

220 - 240V

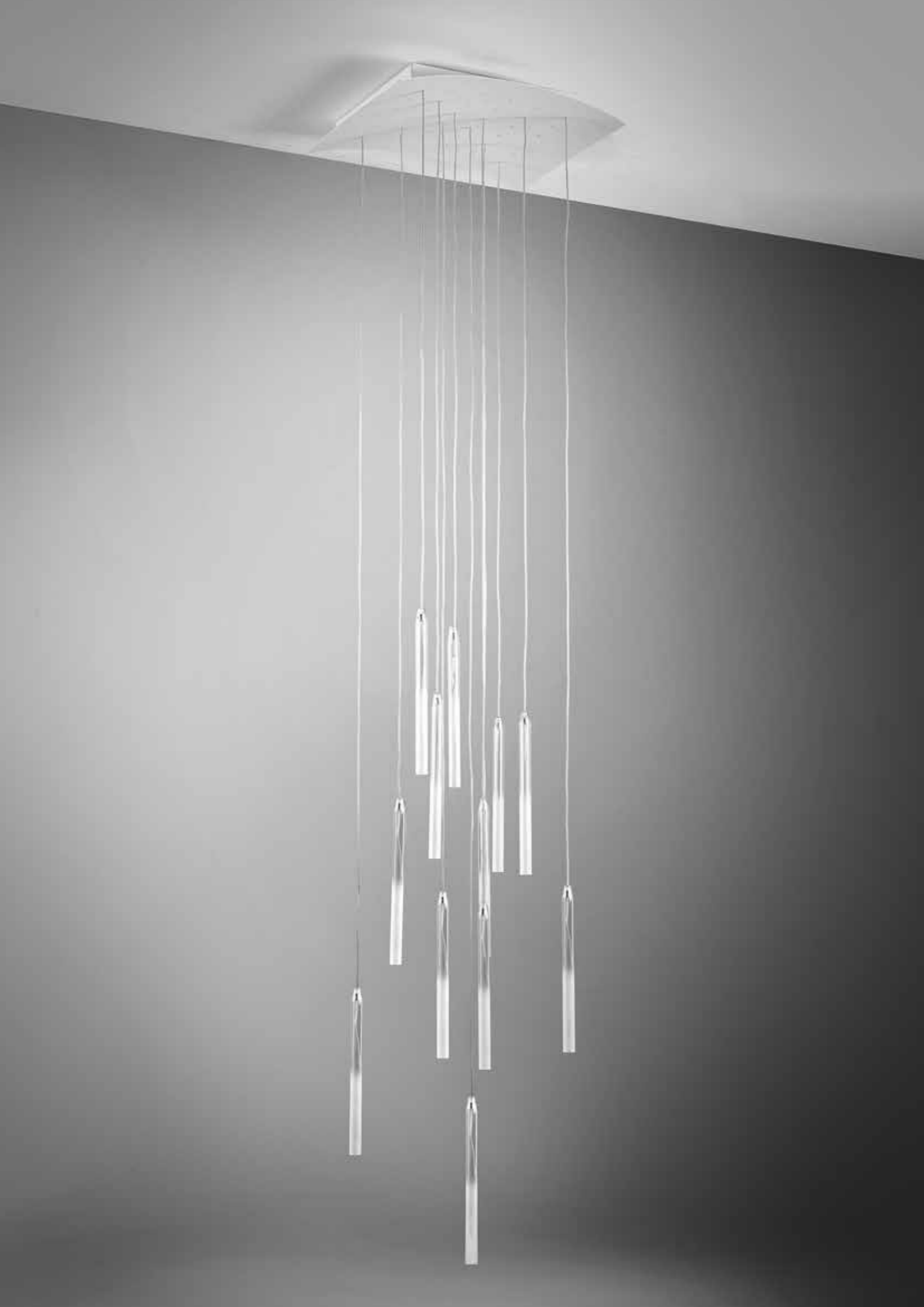

**Waterfalls** | Suspension



**B 151/10**  
 up to 2 modules  
 Net weight 220gr  
 Gross weight 686gr (with 2 Susp.)  
 Volume m<sup>3</sup> 0,009

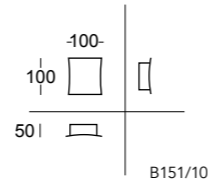

**B 152/90**  
 up to 16 modules  
 Net weight 1810gr  
 Gross weight 5327gr (with 16 Susp.)  
 Volume m<sup>3</sup> 0,039

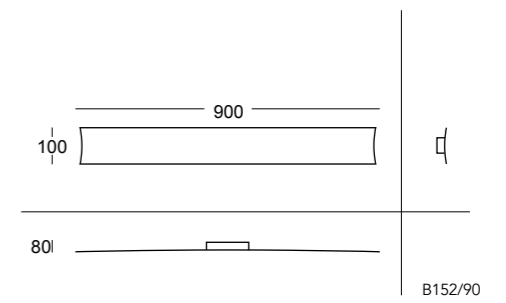

**B 151/20**  
 up to 4 modules  
 Net weight 902gr  
 Gross weight 1736gr (with 4 Susp.)  
 Volume m<sup>3</sup> 0,013

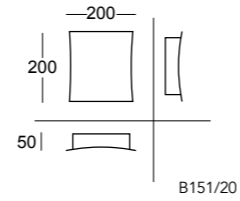

**M151 modulo LED**  
 1x2W LED 700MA 4000°K  
 upon request 3000°K  
 CE IP20  
 Net weight 114gr

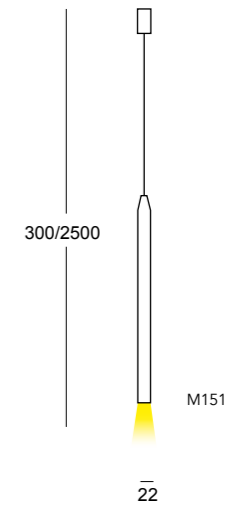

**B 151/29**  
 up to 16 modules  
 Net weight 1809gr  
 Gross weight 5328gr (with 16 Susp.)  
 Volume m<sup>3</sup> 0,046

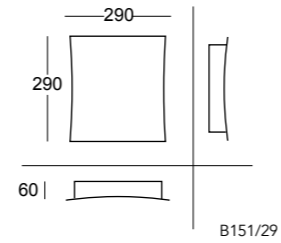

**Waterfall lamps**  
 can be customised by combining:  
 Base + N°Modules + Power Supply



**B 151/40**  
 up to 36 modules  
 Net weight 3000gr  
 Gross weight 8104gr (with 36 Susp.)  
 Volume m<sup>3</sup> 0,066

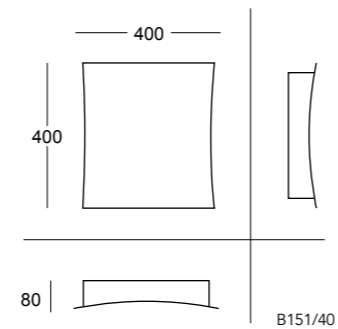

**Driver**  
 D151/1 Driver 1 LED - Net weight 114gr  
 D151/2 Driver 2 LED - Net weight 28gr  
 D151/4 Driver 4 LED - Net weight 94gr  
 D151/7 Driver 7 LED - Net weight 86gr  
 D151/16 Driver 16 LED - Net weight 189gr

# Heron

design by C. Cattaneo

Una lama di luce crea suggestive scenografie. Le varie tipologie: sospensione, applique e plafone, permettono ad Heron di essere versatile nell'installazione e essere un vero e proprio oggetto di design.

A blade of light creates suggestive scenographies. The various types: suspension, wall lamp and ceiling lamp, allow Heron to be versatile in the installation and be a real object of design.

Eine Lichtscheibe erzeugt suggestive Szenografien. Die verschiedenen Typen: Pendelleuchte, Wand- und Deckenleuchte, ermöglichen es Heron, vielseitig in der Installation zu sein und ein echtes Designobjekt zu sein.



**810/75A S - 810/75 AD**

LED 2x6W  
1500lm 3000°K upon request 2700°/4000°K

CE IP20

Net weight 1500gr - Gross weight 2300gr

Volume m<sup>3</sup> 0.080

 with leading edge or trailing edge dimmer

**810/95 AS - 810/95 AD**

LED 3x6W  
2250lm 3000°K upon request 2700°/4000°K

CE IP20

Net weight 2500gr - Gross weight 4300 gr

Volume m<sup>3</sup> 0.080

 with leading edge or trailing edge dimmer

**810/120 AS - 810/120 AD**

LED 4x6W  
3000lm 3000°K upon request 2700°/4000°K

CE IP20

Net weight 3300gr - Gross weight 6300gr

Volume m<sup>3</sup> 0.15

 with leading edge or trailing edge dimmer

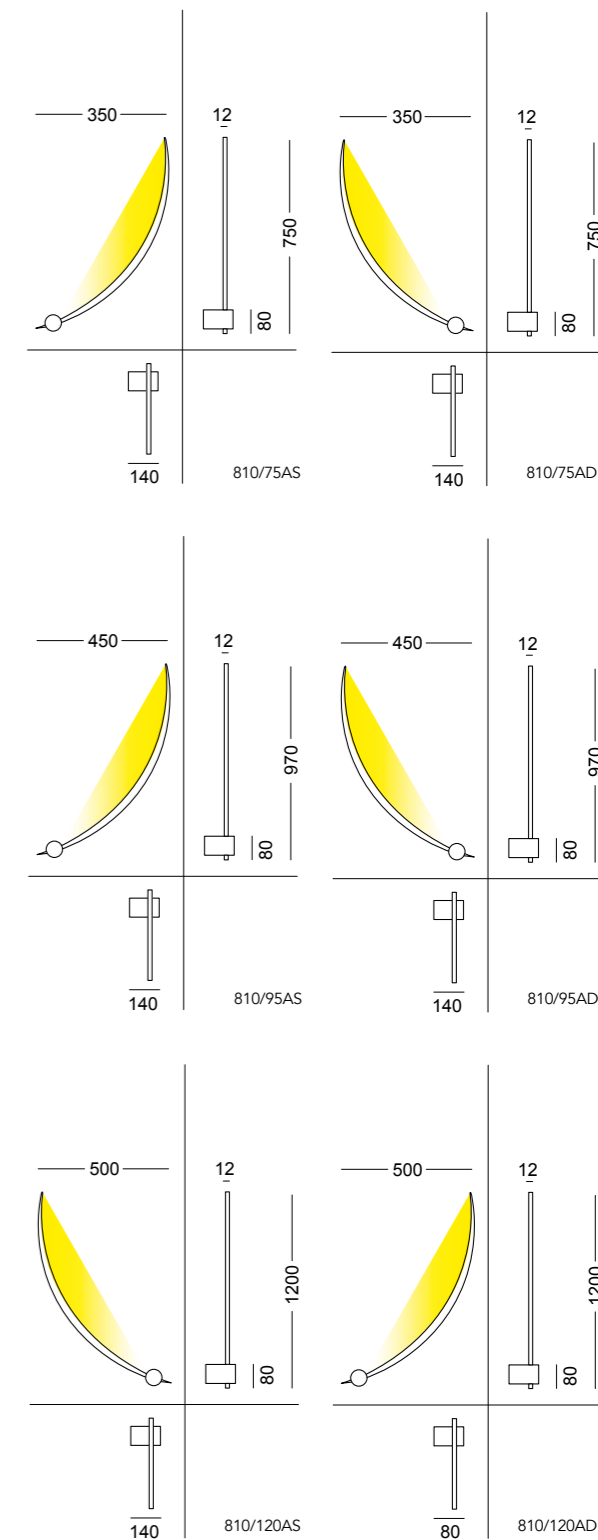

Heron | Wall

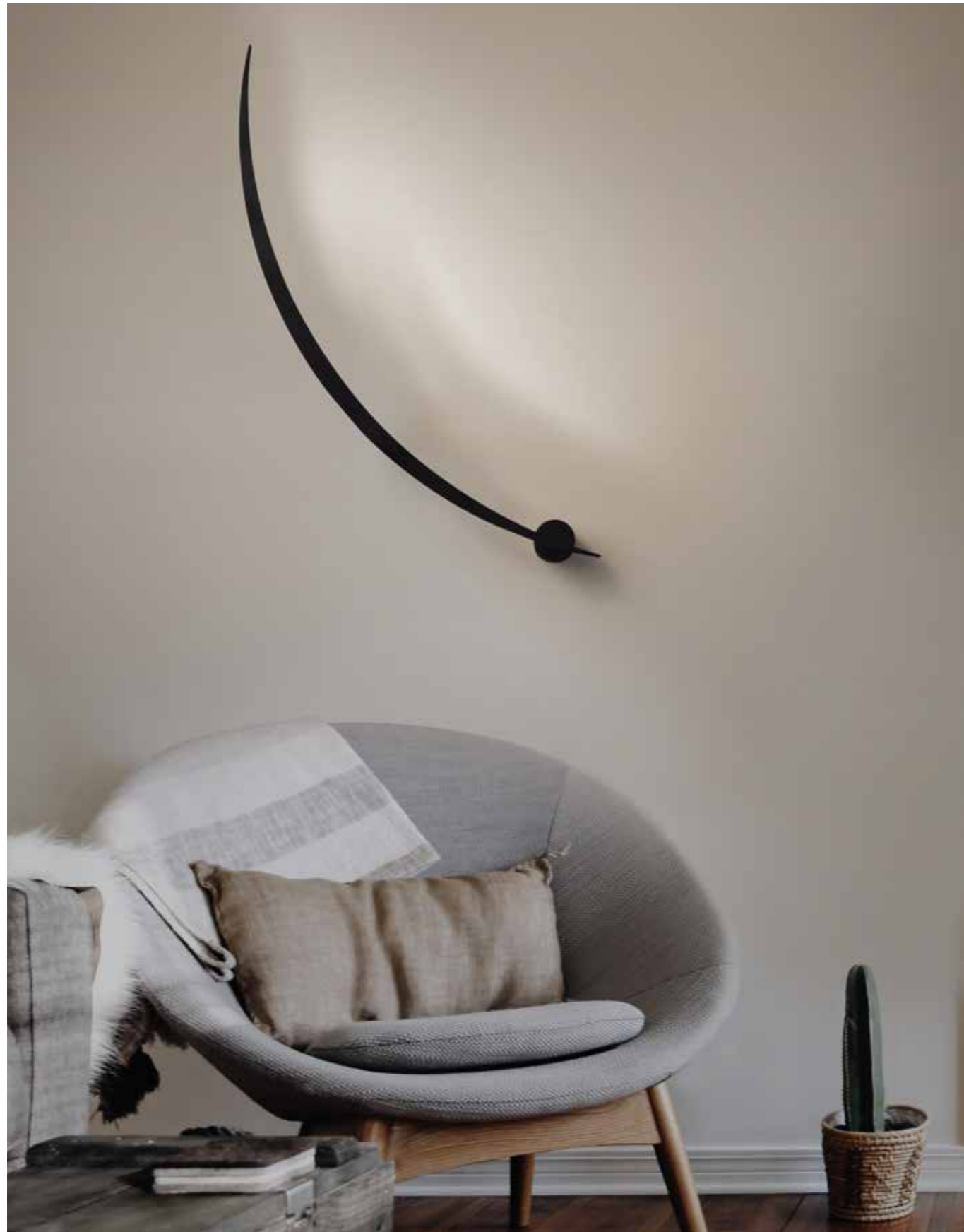

White

Sandy

Matt Black

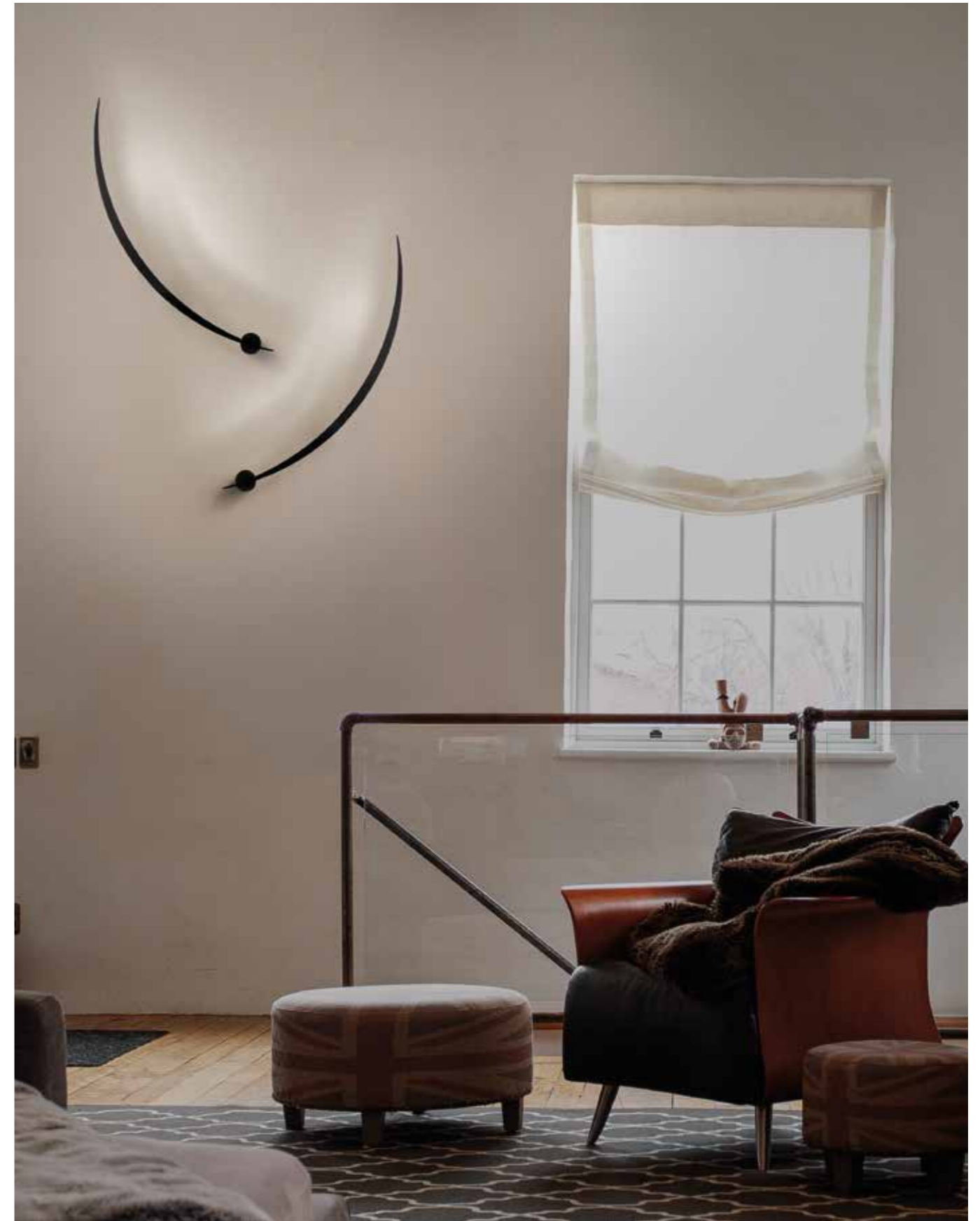



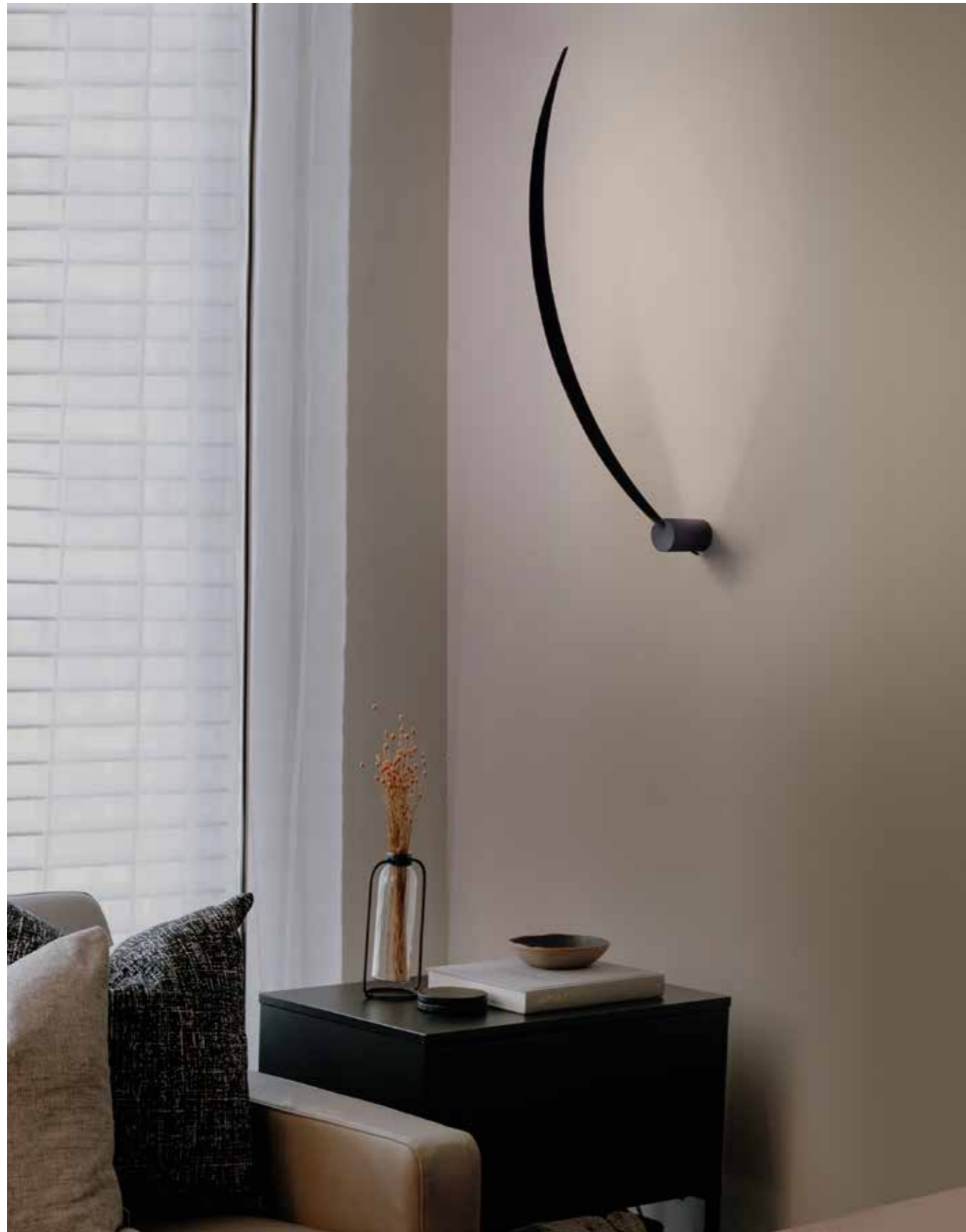



White

Sandy

Matt Black

**810/75 PA**

LED 2x6W

1500lm 3000°K upon request 2700°/4000°K

CE IP20

Net weight 1500gr - Gross weight 2300gr

Volume m<sup>3</sup> 0.080

 with leading edge or trailing edge dimmer

**810/95 PA**

LED 3x6W

2250 lm 3000°K upon request 2700°/4000°K

CE IP20

Net weight 2500gr - Gross weight 4300gr

Volume m<sup>3</sup> 0.080

 with leading edge or trailing edge dimmer

**810/120 PA**

LED 4x6W

3000lm 3000°K upon request 2700°/4000°K

CE IP20

Net weight 3300gr - Gross weight 6300gr

Volume m<sup>3</sup> 0.15

 with leading edge or trailing edge dimmer

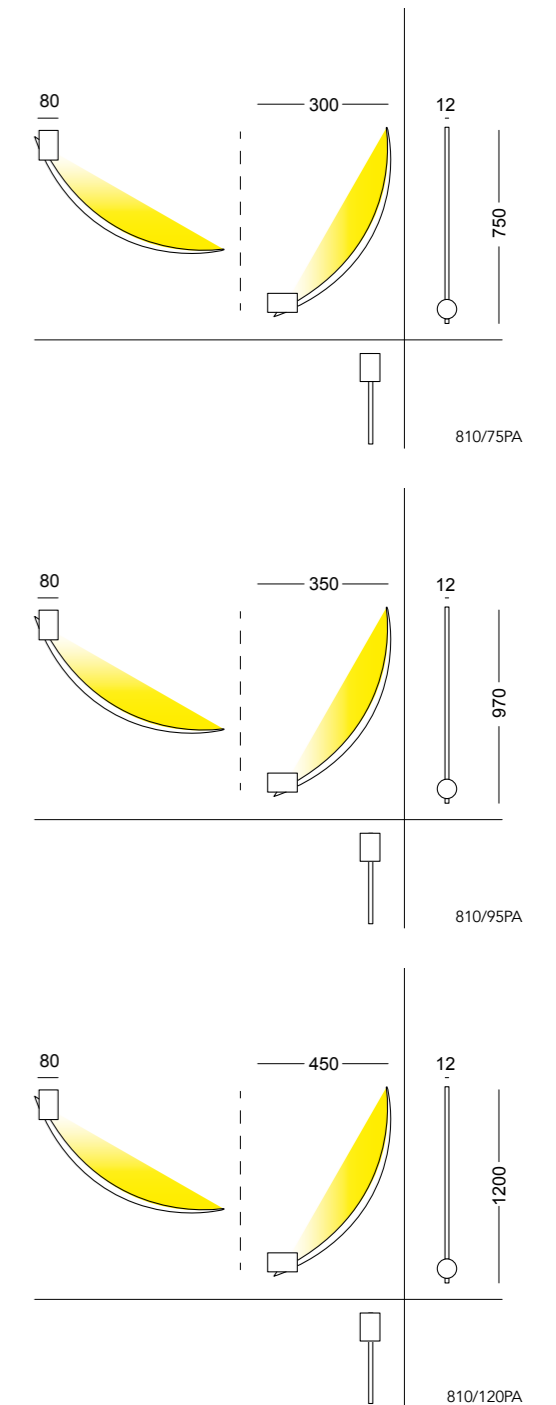

Heron | Ceiling

810/75PA

810/95PA

810/120PA

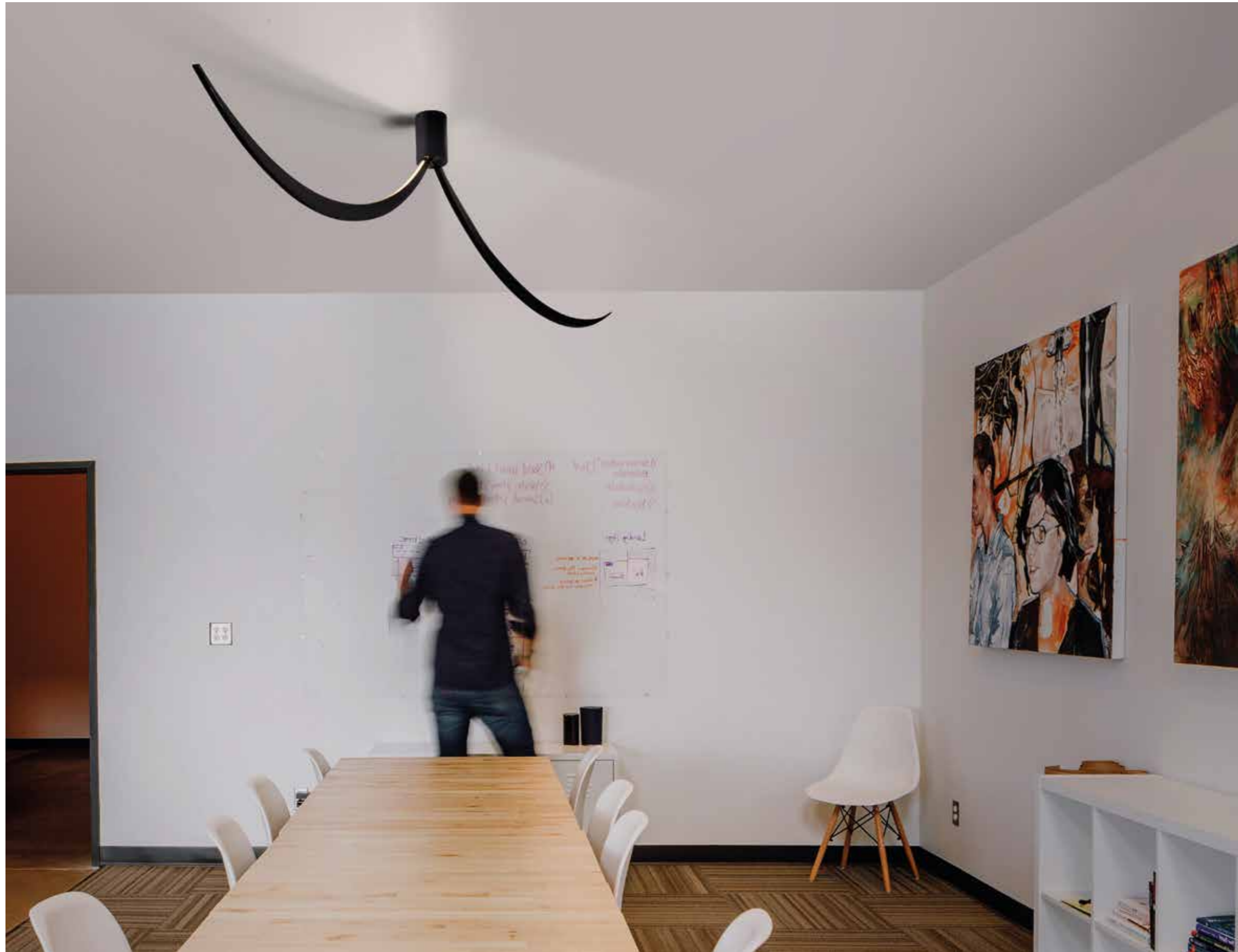

**810/95 P2**  
 LED 6x6W  
 4500lm 3000°K upon request 2700°/4000°K  
 CE IP20  
 Net weight 4500gr - Gross weight 6500gr  
 Volume m<sup>3</sup> 0.080  
 Dimmable with leading edge or trailing edge dimmer

**810/120 P2**  
 LED 8x6W  
 6000lm 3000°K upon request 2700°/4000°K  
 CE IP20  
 Net weight 6100gr - Gross weight 9100gr  
 Volume m<sup>3</sup> 0.15  
 Dimmable with leading edge or trailing edge dimmer

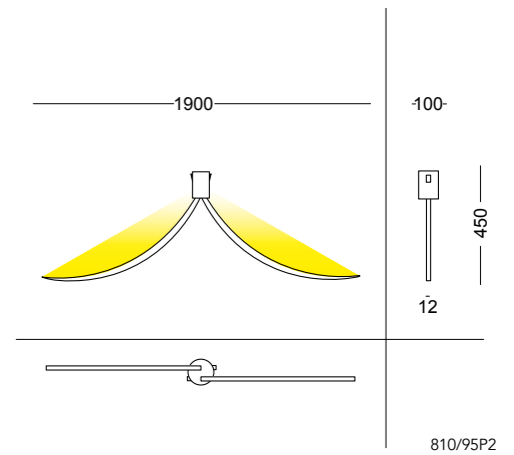

810/95P2

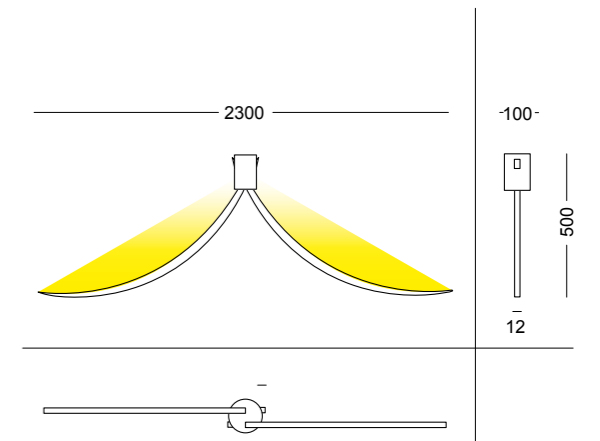

810/120P2

Heron | Ceiling



White

Sandy

Matt Black





**810/95 S**

LED 3x6W  
2250lm 3000°K upon request 2700°/4000°K

CE IP20

Net weight 2500gr - Gross weight 4300gr  
volume m<sup>3</sup> 0.080

Dimmable with leading edge or trailing edge dimmer

**810/120 S**

LED 4x6W  
3000lm 3000°K upon request 2700°/4000°K

CE IP20

Net weight 3300gr - Gross weight 6600gr  
volume m<sup>3</sup> 0.15

Dimmable with leading edge or trailing edge dimmer

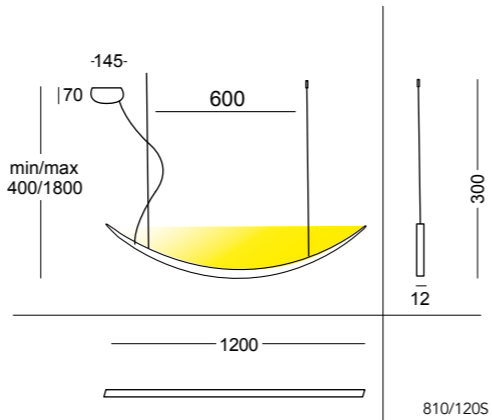
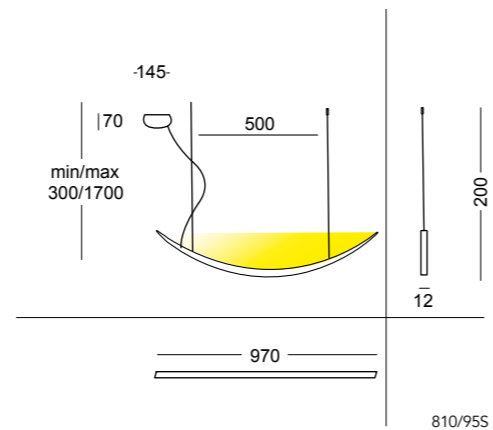

**810/95 M**

LED 3x6W  
2250lm 3000°K upon request 2700°/4000°K

CE IP20

Net weight 2500gr - Gross weight 4300gr  
volume m<sup>3</sup> 0.080

Dimmable with leading edge or trailing edge dimmer

**810/120 M**

LED 4x6W  
3000lm 3000°K upon request 2700°/4000°K

CE IP20

Net weight 3300gr - Gross weight 6600gr  
volume m<sup>3</sup> 0.15

Dimmable with leading edge or trailing edge dimmer

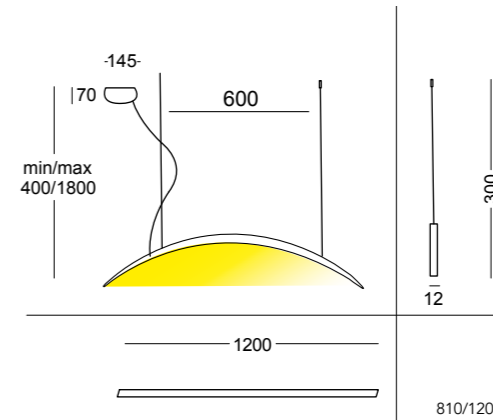
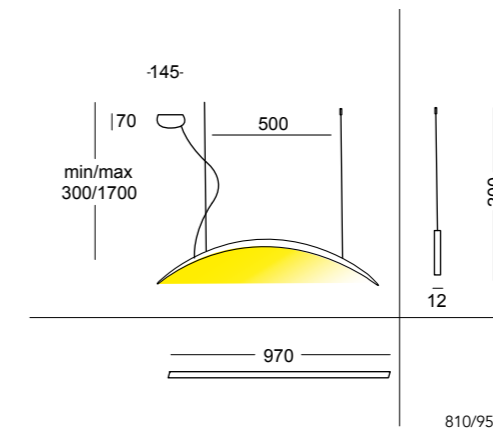

**Base**

**810/15 R2**

Net weight 500gr  
Gross weight 1500gr  
Volume m<sup>3</sup> 0.009

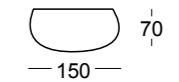

**810/15 R3**

Net weight 600gr  
Gross weight 1600gr  
Volume m<sup>3</sup> 0.009

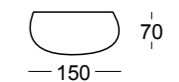

# Dinamica

design by Eaproject



Un disco leggero e compatto ritmato al suo interno da un sistema di linee concentriche che, oltre a trasportare la luce, definiscono un effetto visivo di moto perpetuo. Dinamica è una collezione di lampade circolari proposta in tre dimensioni, contraddistinta dalla totale assenza di angoli e di linee spezzate. Queste caratteristiche essenziali, consentendo una percezione sempre fluida nello spazio, definiscono un design senza tempo adattabile perfettamente ai contesti domestici e ideale per le configurazioni contract.

A light and compact disc characterised by a system of concentric lines within it, that not only carry the light, but also define a visual effect of a never-ending motion. Dinamica is a range of round lights available in three different sizes, marked by a complete lack of angles or fragmented lines. These essential characteristics allow an always fluid space perception and define a timeless design perfectly suitable for household context and ideal for custom-made compositions.

Eine leichte und kompakte Scheibe mit einem System von konzentrischen Linien, die nicht nur Licht tragen, sondern auch einen visuellen Effekt der ständigen Bewegung definieren. Dinamica ist eine Sammlung von ringförmigen Lampen, die in drei Dimensionen angeboten werden, die sich durch die völlige Abwesenheit von Winkeln und unterbrochenen Linien auszeichnen. Diese wesentlichen Eigenschaften, die eine fließende Wahrnehmung im Raum ermöglichen, definieren ein zeitloses Design, das sich perfekt an den häuslichen Kontext anpasst und sich ideal für Vertragskonfigurationen eignet.

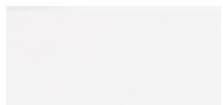

White





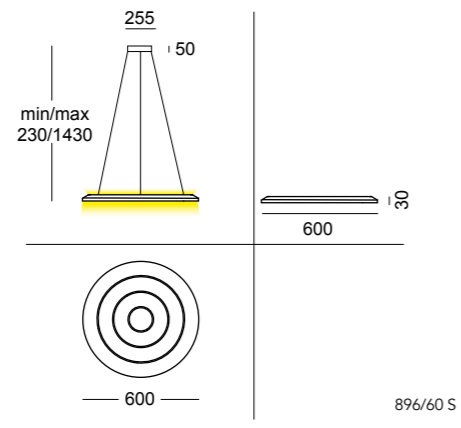

896/60 S

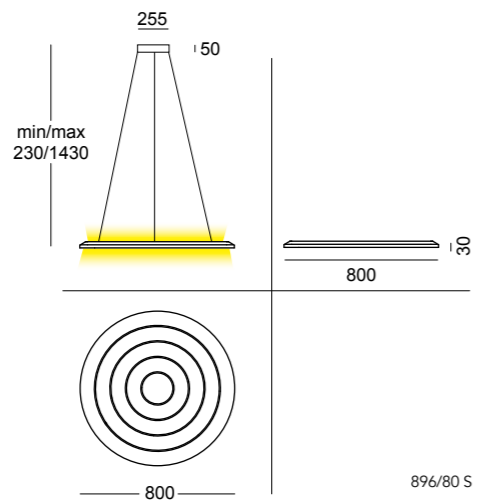

896/80 S

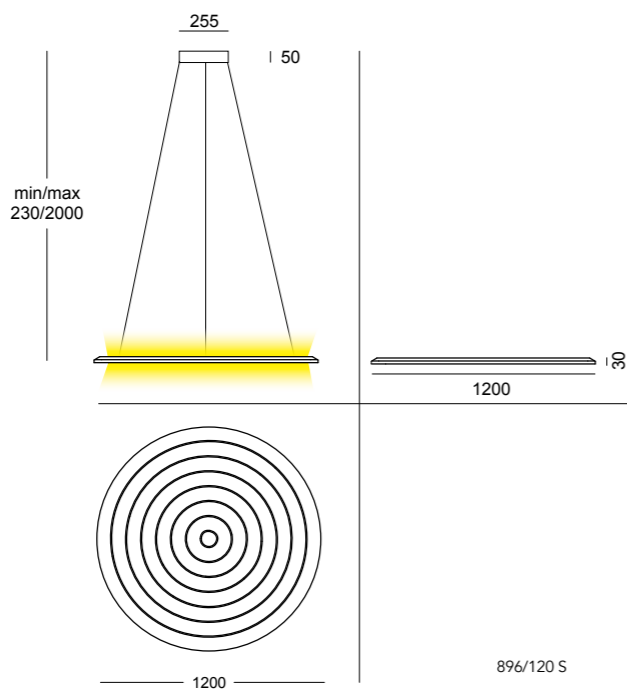

896/120 S

**896/60 S**

LED 54W 230V  
 2400lm 3000°K  
 CE IP20  
 Net weight 5900gr  
 Gross weight 7300gr  
 Volume m<sup>3</sup> 0,147  
 Dimmable dali/push/1-10v

**896/80 S**

LED 90W 230V  
 4000lm 3000°K  
 CE IP20  
 Net weight 9200gr  
 Gross weight 10900gr  
 Volume m<sup>3</sup> 0,30  
 Dimmable dali/push/1-10v

**896/120 S**

LED 180W 230V  
 6400lm 3000°K  
 CE IP20  
 Net weight 20700gr  
 Gross weight 24600gr  
 Volume m<sup>3</sup> 0,845



# Well

design by C. Cattaneo



La luce è movimento: dall'alba al crepuscolo l'universo si trasforma in configurazioni luminose sempre diverse a seconda degli orari del giorno. Well è in grado di modificare la luce emessa grazie ad un semplice gesto che trasforma il suo fascio da diretto a indiretto, modificando la percezione dello spazio circostante e adattando il tipo di luce a specifici bisogni. Un cilindro principale con funzione diffondente e un cilindro inferiore che contiene la sorgente led, sono le componenti essenziali di questa lampada che appare come un lucernario all'interno degli ambienti, adattandosi con naturalezza alle più svariate esigenze di utilizzo.

Light is movement: from sunrise to sunset the universe turns into always different luminous configurations depending on the time of the day. Well is able to adjust the light released thanks to a simple gesture that converts its beam of light from direct to indirect, modifying the sense of the surrounding space and adjusting the light to specific needs. A main cylinder with a diffusing function and a lower cylinder holding the LED source are the essential components of this light that appears as a skylight in an environment, masterly complying with the most varied needs.

Licht ist Bewegung: Von morgens bis abends verwandelt sich das Universum in leuchtende Konfigurationen, die je nach Tageszeit immer unterschiedlich sind. Well ist in der Lage, das ausgestrahlte Licht durch eine einfache Geste zu verändern, die seinen Strahl von direkt auf indirekt umwandelt, die Wahrnehmung des umgebenden Raumes verändert und die Art des Lichts an die spezifischen Bedürfnisse anpasst. Ein Hauptzylinder mit Diffusionsfunktion und ein unterer Zylinder mit der LED-Quelle sind die folgenden wesentliche Bestandteile dieser Lampe, die wie ein Oberlicht in den Räumen aussieht und sich natürlich an die unterschiedlichsten Nutzungsbedürfnisse anpasst.





White

Sandy

Blue

Green

Champagne



Well | Ceiling

**893/40 PA**

LED 1x25W 230V

2500lm 3000°K upon request 2700°/4000°K

CE IP20

Net weight 2900gr - Gross weight 4850gr

Volume m<sup>3</sup> 0,066

 PHASE-CUT DIMMING

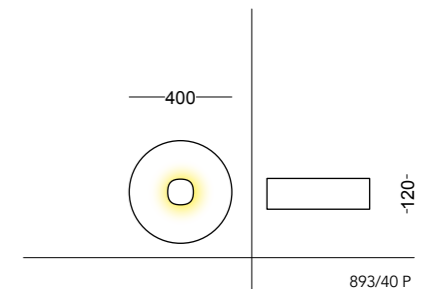

893/40 P

# Thesis

design by Perlage

Una forma arcuata come una parentesi è il segno che contraddistingue Thesis: una lampada essenziale, ma dal forte carattere, proposta in due dimensioni. Un innovativo sistema di connessione permette di abbinare due o più moduli per creare infinite combinazioni. Le geometrie pure che la compongono, enfatizzate da un'efficiente sorgente a luce indiretta, consentono un agevole utilizzo sia a parete che a soffitto. L'estrema versatilità unita alla forma scultorea rendono Thesis protagonista degli ambienti sia da accesa che da spenta.

An arcuate shape as much as a parenthesis is the characteristic of Thesis: an essential light with a strong personality, available in two sizes. An innovative connection system enables to combine together two or more modules, creating endless combinations. Its pure geometries are emphasized thanks to a wise use of indirect light, allowing a simple installation either on the ceiling or onto the wall. The exceptional versatility combined with the sculpted shape make Thesis become the protagonist of the environment either turned on or off.

Eine geschwungene Form wie eine Klammer ist das Zeichen, das Thesis auszeichnet: eine essentielle Lampe, aber mit einem starken Charakter, vorgeschlagen in zwei Dimensionen. Ein innovatives Verbindungssystem ermöglicht die Kombination von zwei oder mehreren Modulen zu unendlichen Kombinationen. Die reinen Geometrien, die es bilden, werden durch eine effiziente indirekte Lichtquelle betont und ermöglichen einen einfachen

Einsatz sowohl an der Wand als auch an der Decke. Die extreme Vielseitigkeit in Kombination mit der skulpturalen Form machen Thesis zum Protagonisten sowohl in On- als auch in Off-Umgebungen





White

Sandy

Blue

Grey



**894/60 PA**

LED 1x15W 230V  
 2000lm 3000°K upon request 2700°/4000°K  
 CE IP20  
 Net weight 2900gr - Gross weight 4200gr  
 Volume m<sup>3</sup> 0,065  
 Dimmable PHASE-CUT DIMMING

**894/70 PA**

LED 1x15W 230V  
 2000lm 3000°K upon request 2700°/4000°K  
 CE IP20  
 Net weight 1700gr - Gross weight 3430gr  
 Volume m<sup>3</sup> 0,052  
 Dimmable PHASE-CUT DIMMING

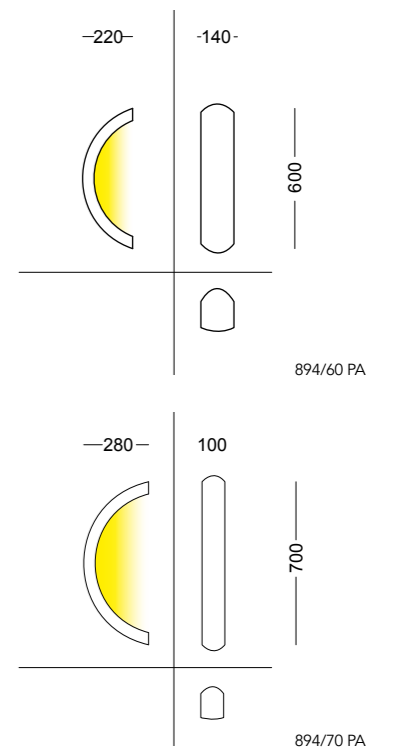

894/60 PA

894/70 PA



**Base accessory**

**894/30 C**

CE IP20

Net weight 1133gr - Gross weight 1702gr

Volume m<sup>3</sup> 0,019

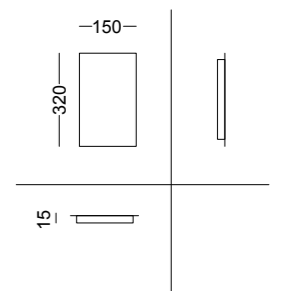



# Kami

design by C. Cattaneo

Un gesto che ricorda la cultura orientale degli origami e che ne diventa espressione contemporanea. Attraverso un'unica piegatura e un taglio diagonale sapientemente disegnato, Kami è in grado di celare la fonte luminosa per lasciare spazio ad una sfumatura di luce che diventa così la vera protagonista di questo prodotto scultoreo. La doppia cromia tra esterno ed interno enfatizza l'effetto luminoso e rende la lampada personalizzabile e adattabile a qualsiasi ambiente. La collezione, composta da lampade a sospensione disponibili in due dimensioni, è completata da una versione a parete.

A gesture reminding the Eastern culture of the origami, becoming its contemporary expression. Thanks to its unique bending and its wisely designed diagonal cut, Kami is able to conceal the light source leaving space to hues of light: real protagonists of this sculpted product. The double tone between inside and outside emphasises the luminous effect. In this way the light can be customized, becoming suitable for any environment. The collection, made up of pendant lights available in two sizes, is integrated by a wall variation.

Eine Geste, die an die orientalische Kultur des Origami erinnert und zu seinem zeitgenössischen Ausdruck wird. Durch eine einzige Falte und einen raffiniert gestalteten Schrägschnitt kann Kami die Lichtquelle verstecken, um Platz für eine Lichtnuance zu schaffen, die zum eigentlichen Protagonisten dieses skulpturalen Produkts wird. Die doppelte Farbgebung zwischen Außen und Innen unterstreicht die Lichtwirkung und macht die Leuchte anpassbar und anpassungsfähig an jede Umgebung. Die Kollektion, bestehend aus Pendelleuchten in zwei Größen, wird durch eine Wandversion ergänzt.



White

Sandy

Blue

Green

Champagne

Grey





**891/90 S**

LED 2x15W 230V  
 4000lm 3000°K upon request 2700°/4000°K  
 CE IP20  
 Net weight 1590gr - Gross weight 3495gr  
 Volume m<sup>3</sup> 0,090  
 PHASE-CUT DIMMING



**891/120 S**

LED 3x15W 230V  
 6000lm 3000°K upon request 2700°/4000°K  
 CE IP20  
 Net weight 2350gr - Gross weight 5000gr  
 Volume m<sup>3</sup> 0,090  
 PHASE-CUT DIMMING

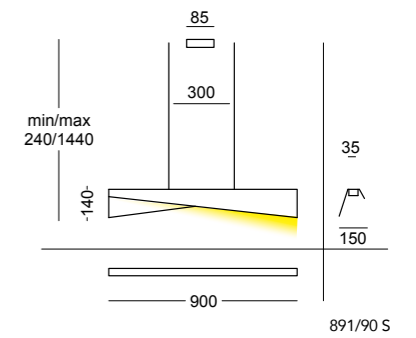

891/90 S

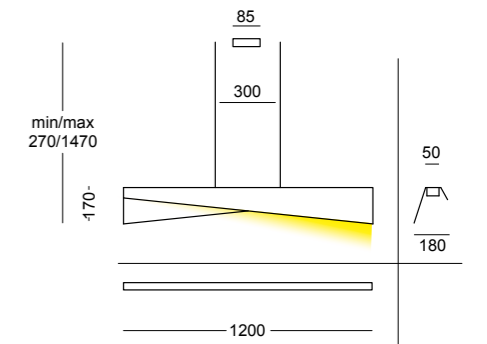

891/120 S





**891/30 A**  
 LED 1x15W 230V  
 1500lm 3000°K upon request 2700°/4000°K  
 CE IP20  
 Net weight 300gr - Gross weight 640gr  
 Volume m<sup>3</sup> 0,012  
 Dimmable PHASE-CUT DIMMING

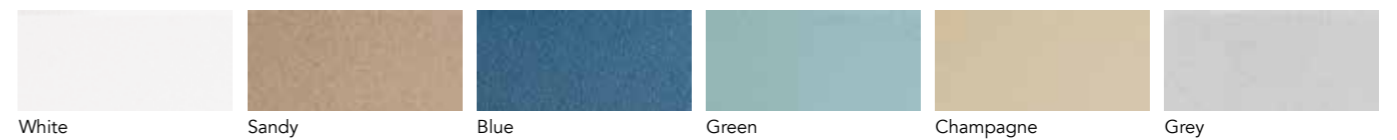
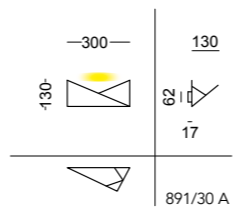

Kami | Wall

# Volvit

design C. Cattaneo



Un foglio di metallo che avvolge un diffusore opalino sono le componenti essenziali di questo prodotto. Un'applicazione minimale, ma allo stesso tempo sofisticata, dove il cuore luminoso viene celato e custodito per essere rivelato solo quando viene accesa. Le varianti colore e le due dimensioni in cui viene proposta, trasformano Volvit in un segno grafico capace di donare dinamismo alle pareti domestiche e non, rendendola adatta sia agli spazi contemporanei che agli ambienti più classici.

A sheet of metal enclosing an opaline diffuser. These are the essential components of this product. A minimal, but at the same time sophisticated wall light, in which the luminous heart remains concealed and shield to be revealed only once the light turned on. The available finishes and sizes turn Volvit into a graphic sign able to offer dynamism to the household and not just that, making it suitable for both contemporary and classical environments.

Ein Metallblech, das sich um eine opale Abdeckung legt, sind die wesentlichen Bestandteile dieses Produkts. Eine minimale, aber gleichzeitig raffinierte Wandleuchte, bei der das leuchtende Herz verborgen und bewacht wird, um erst beim Einschalten enthüllt zu werden. Die Farbvariationen und die beiden Dimensionen, in denen sie vorgeschlagen werden, verwandeln Volvit in ein grafisches Zeichen, das in der Lage ist, Wohn- und Nichtwohnwänden Dynamik zu verleihen, was es sowohl für zeitgenössische Räume als auch für eher klassische Umgebungen geeignet macht.

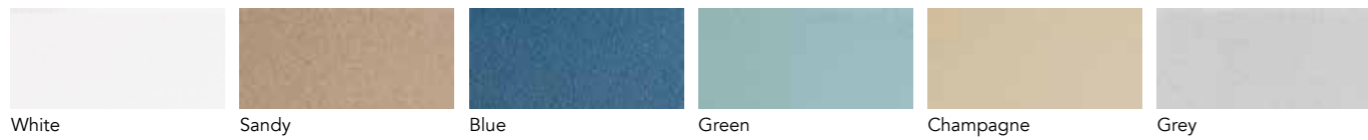



**892/15 A**  
 LED 1x8W 230V  
 750lm 3000°K upon request 2700°/4000°K  
 CE IP20  
 Net weight 280gr - Gross weight 530gr  
 Volume m<sup>3</sup> 0,0092  
 Dimmable PHASE-CUT DIMMING

**892/18 A**  
 LED 1x15W 230V  
 1500lm 3000°K upon request 2700°/4000°K  
 CE IP20  
 Net weight 350gr - Gross weight 700gr  
 Volume m<sup>3</sup> 0,0120  
 Dimmable PHASE-CUT DIMMING

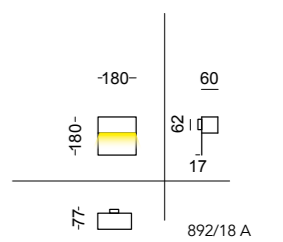
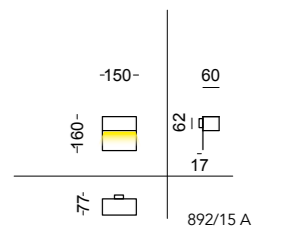



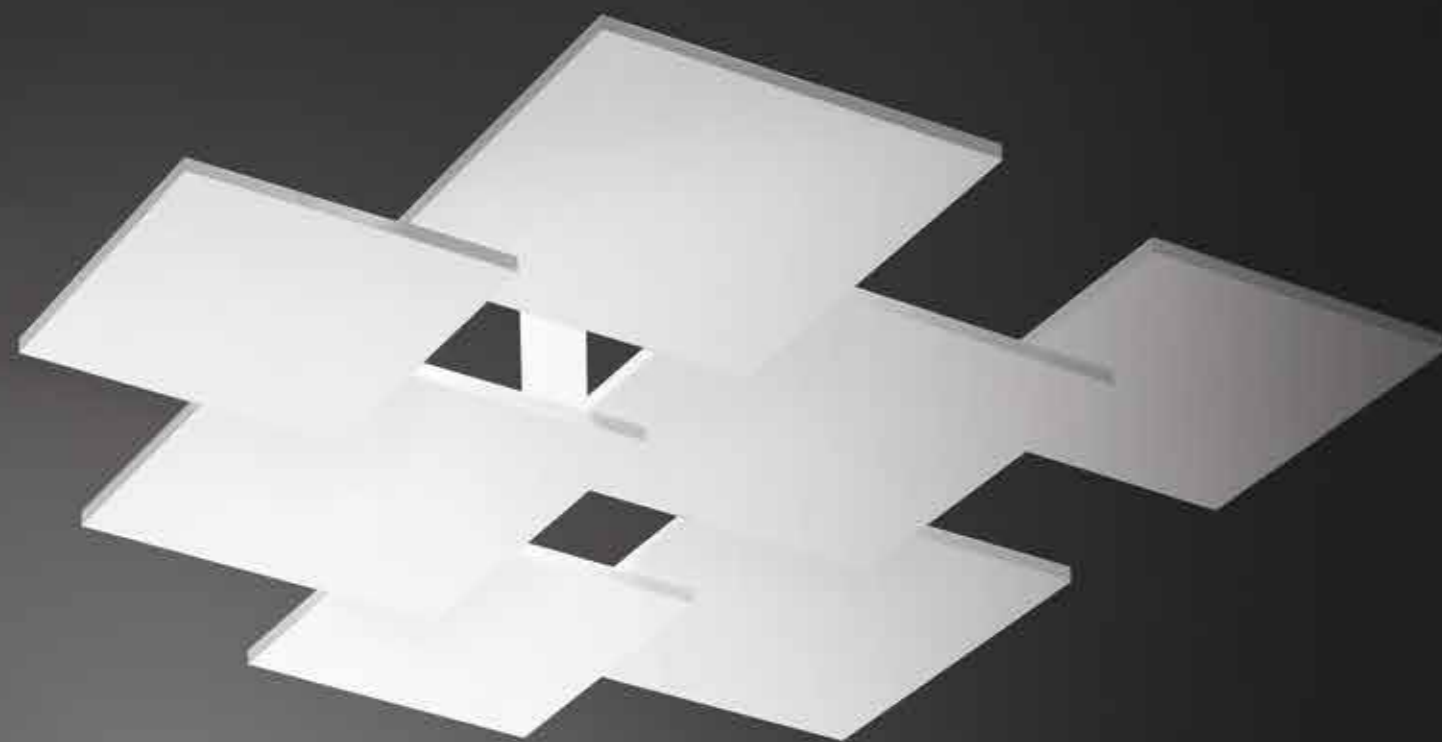

# Basalt

design by C. Cattaneo

Una stratificazione di livelli geometrici costituisce la forma della lampada Basalt, plafoniera in grado di mimetizzarsi nello spazio ma allo stesso tempo di arricchirlo con una tridimensionalità inattesa. Concepita assemblando elementi geometrici primari, Basalt produce una luce indiretta e trasforma la superficie in cui viene installata in diffusore capace di illuminare lo spazio in modo omogeneo ed elegante, creando sempre un'atmosfera adatta ad ogni esigenza.

A stratification of geometrical layers makes up the shape of Basalt, a ceiling light able to camouflage itself in the space, but at the same time to enhance the environment with an unexpected three-dimensional effect. Basalt has been conceived assembling primary geometrical elements. It casts an indirect light that turns the surface into a diffuser able to illuminate the space homogeneously and gracefully, creating the perfect atmosphere for all needs.

Eine Schichtung geometrischer Ebenen bildet die Form der Basaltlampe, einer Deckenleuchte, die sich im Raum tarnen, aber gleichzeitig mit einer unerwarteten Dreidimensionalität bereichern kann. Basalt wurde durch die Montage von primären geometrischen Elementen entwickelt, erzeugt indirektes Licht und verwandelt die Oberfläche, in der es installiert ist, in einen Diffusor, der in der Lage ist, den Raum homogen und elegant zu beleuchten und immer eine für jeden Bedarf geeignete Atmosphäre zu schaffen.

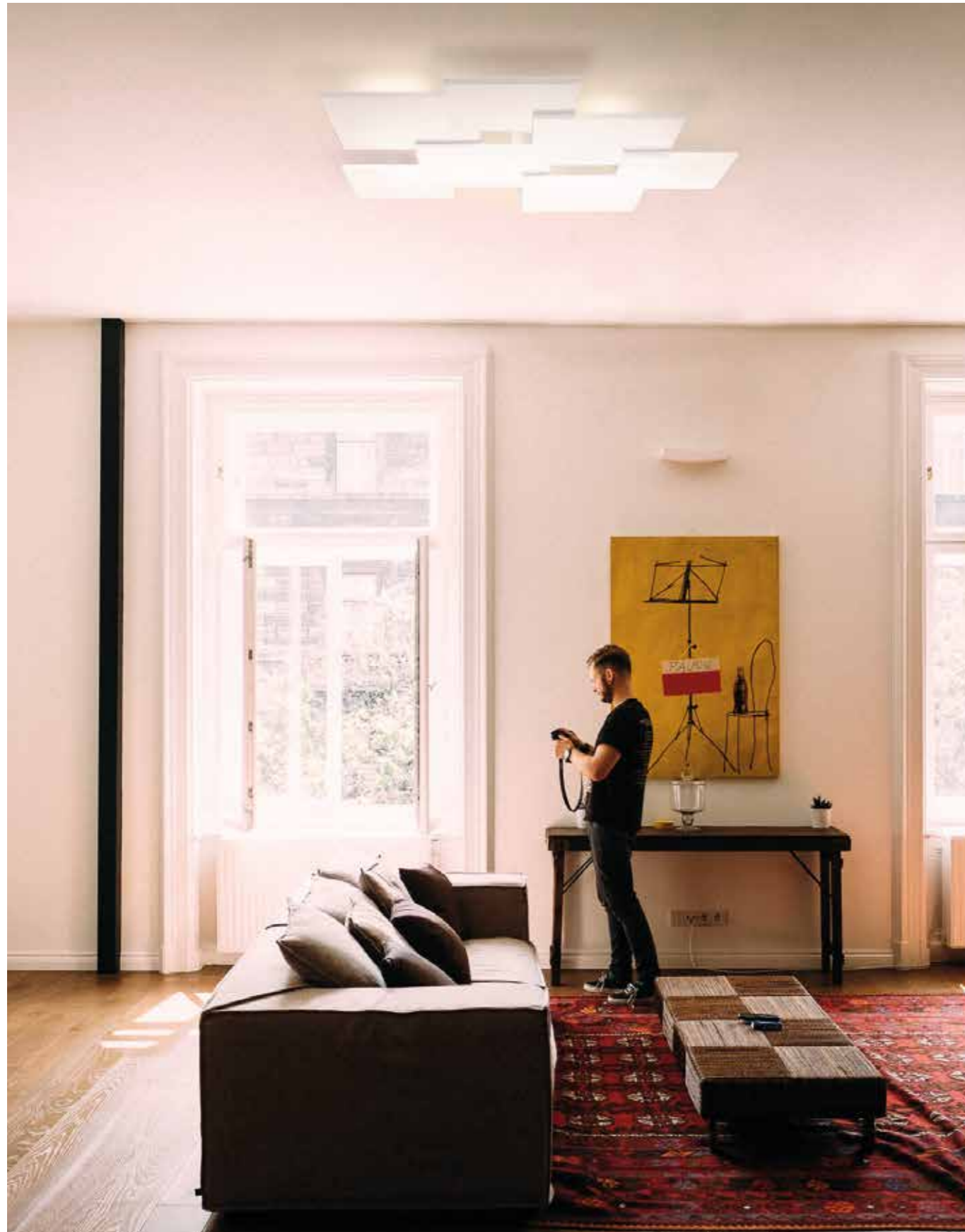

**897/60 P**

LED 3x17W 230V

4500lm 3000°K upon request 2700°/4000°K

CE IP20

Net weight 3220gr - Gross weight 5700gr

Volume m<sup>3</sup> 0,11

 PHASE-CUT DIMMING

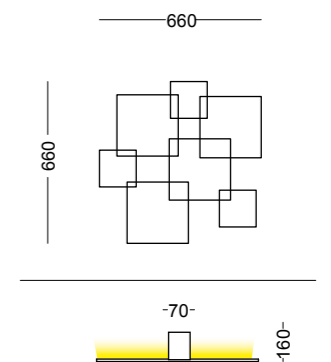

897/60 P

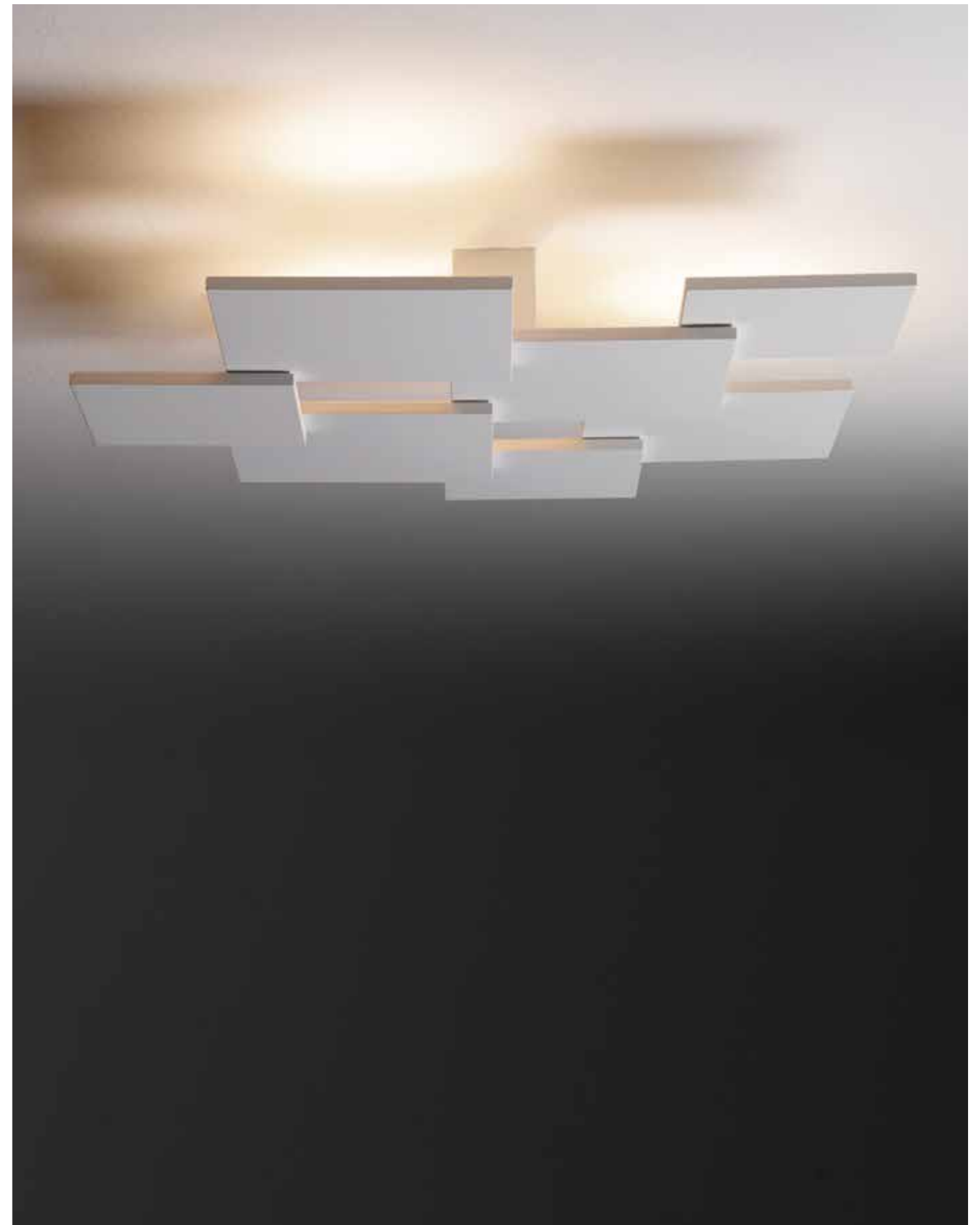

**Basalt** | Ceiling



# Ninfea

design by C. Cattaneo

Una sovrapposizione di forme curve compone questa lampada che, come le foglie di una ninfea, si appoggia leggera sulla superficie in cui viene installata. Ninfea emana una luce indiretta che illumina gli spazi con morbidezza creando dinamiche atmosfere chiaroscurali grazie alla possibilità di aumentare o diminuire l'intensità di luce emessa. La sua presenza non invasiva permette a Ninfea di dialogare con l'ambiente circostante divenendo parte integrante dell'interior design. Un prodotto con tecnologia led che coniuga qualità, design e artigianalità.

This light is made up of an overlapping of curved shapes that, as the leaves of a water lily, lean lightly into the surface on which they are installed. Ninfea releases an indirect light that enlightens the space with softness, creating dynamic light and dark atmospheres, thanks to the chance of increasing and decreasing the intensity of light. Its non-invasive presence, allows Ninfea to converse with the surrounding environment becoming integral part of the interior design. A product with LED technology combining quality, design and craftsmanship.

Eine Überlagerung von geschwungenen Formen bildet diese Lampe, die wie die Blätter einer Seerose leicht auf der Oberfläche liegt, auf der sie installiert ist. Ninfea emittiert ein indirektes Licht, das die Räume weich ausleuchtet und dank der Möglichkeit, die Intensität des emittierten Lichts zu erhöhen oder zu verringern, dynamische Hell-Dunkel-Atmosphären erzeugt. Seine nicht-invasive Präsenz ermöglicht es Ninfea, mit der Umgebung zu kommunizieren und wird so zu einem integralen Bestandteil der Innenarchitektur. Ein Produkt mit LED-Technologie, das Qualität, Design und Handwerk vereint.



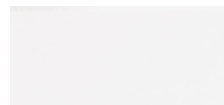

White



**895/70 P**

LED 2x17W

3000lm 3000°K upon request 2700°/4000°K

CE  IP20

Net weight 2868gr - Gross weight 4880gr

Volume m<sup>3</sup> 0,089

 PHASE-CUT DIMMING

**895/90 P**

LED 3x17W 230V

4500lm 3000°K upon request 2700°/4000°K

CE  IP20

Net weight 4170gr - Gross weight 7600gr

Volume m<sup>3</sup> 0,174

 PHASE-CUT DIMMING

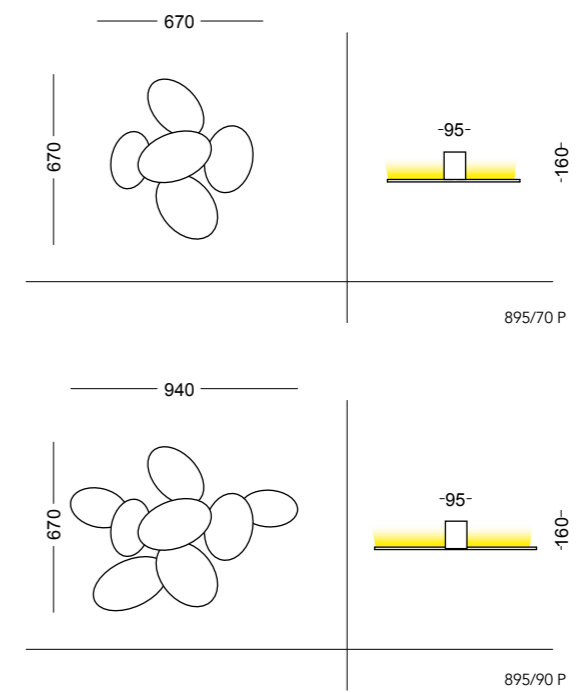

# Katana

design by C. Cattaneo | EA Project



L'ampia superficie di illuminazione e la doppia emissione di luce sono le parole chiave per questa Sospensione. La Katana, la lampada futuristica per un'illuminazione tagliente.

The wide lighting surface and the bi- emission of light are the keywords of this pendant light. Katana, the futuristic light for a sharp illumination.

Geräumige Beleuchtungsfläche und Doppel Emission Licht sind die Stichpunkten dieser Pendeleuchte. Katana ist eine futuristische Leuchte für eine scharfsinnige Beleuchtung.

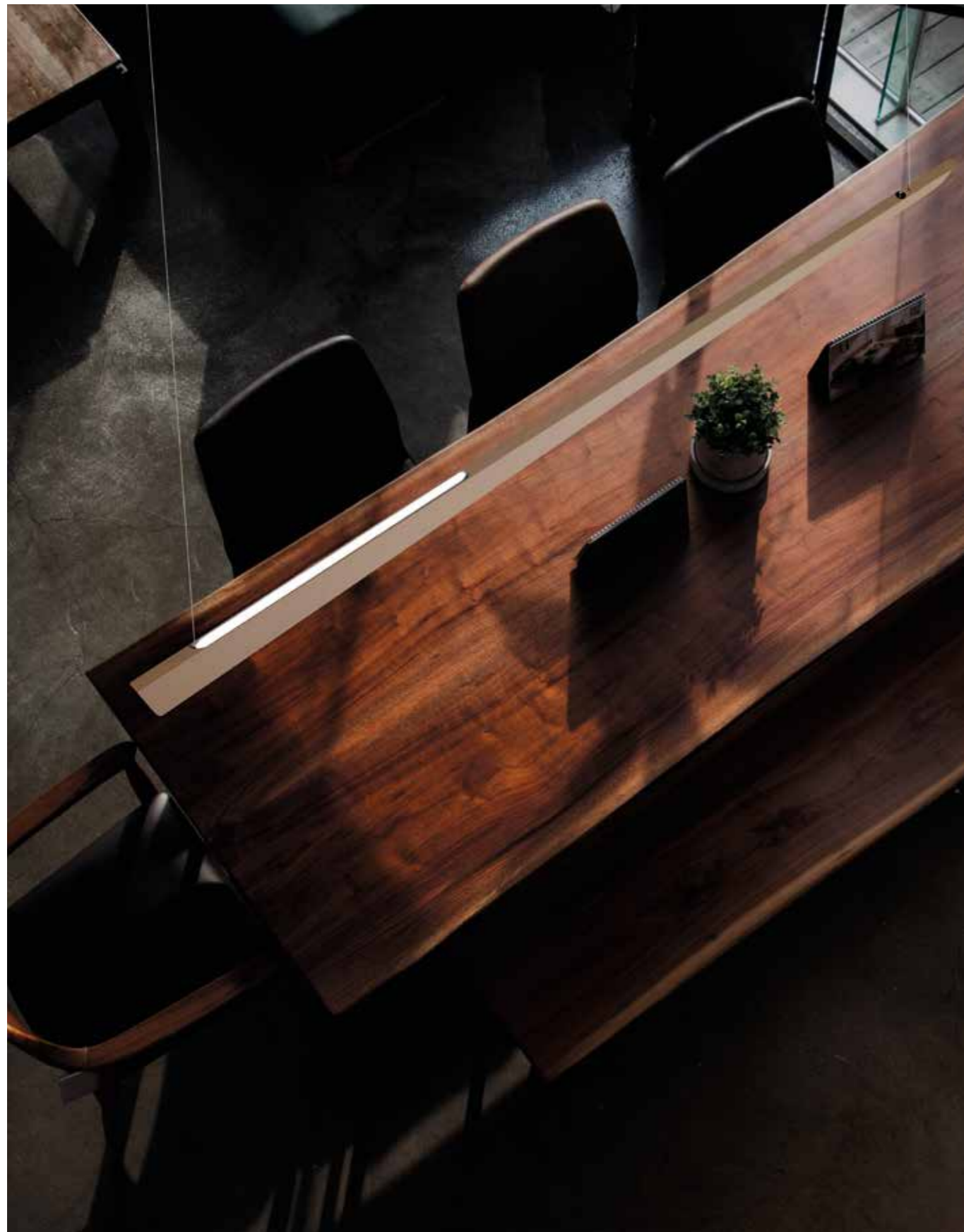

White

Sandy

Matt Black



**870/100 S**

LED 3x7+1x7W

4000lm 3000°K upon request 2700°/4000°K

CE IP20

Net weight 1510gr - Gross weight 2710gr

Volume m<sup>3</sup> 0,021

with leading edge or trailing edge dimmer

**870/130 S**

LED 4x7W + 2x7W

6000lm 3000°K upon request 2700°/4000°K

CE IP20

Net weight 2300gr - Gross weight 4400gr

Volume m<sup>3</sup> 0,05244

with leading edge or trailing edge dimmer

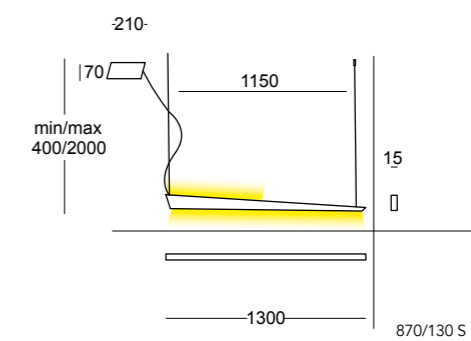
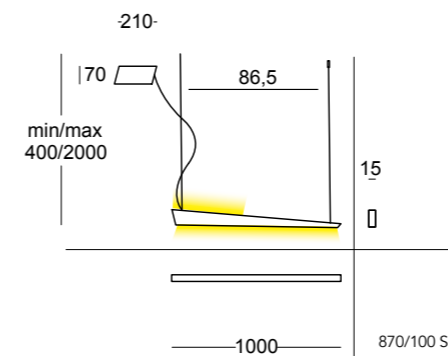





White

Sandy

Matt Black

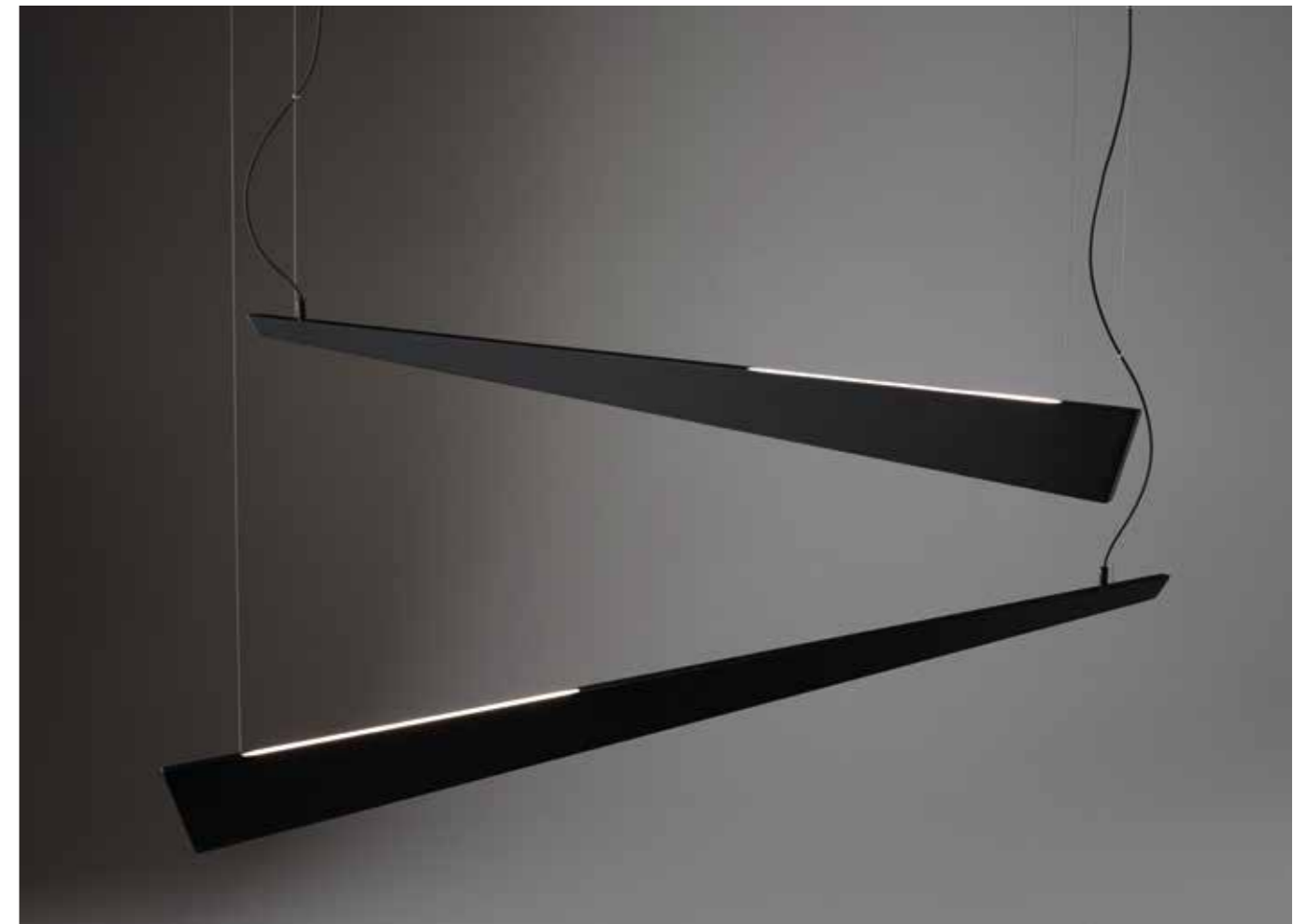

**870/100 S2**

LED 6x7W + 2x7W

8000lm 3000°K upon request 2700°/4000°K

CE IP20

Net weight 3600gr - Gross weight 5400gr

Volume m<sup>3</sup> 0,021

with leading edge or trailing edge dimmer

**870/130 S2**

LED 8x7W + 4x7W

12000lm 3000°K upon request 2700°/4000°K

CE IP20

Net weight 4500gr - Gross weight 9200gr

Volume m<sup>3</sup> 0,052

with leading edge or trailing edge dimmer

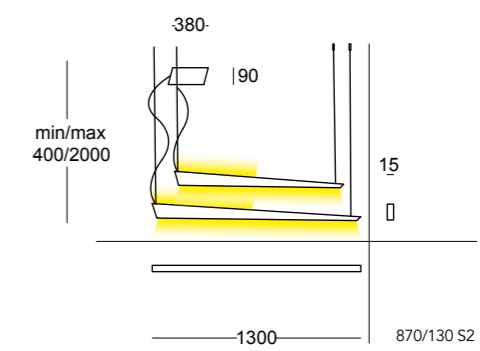
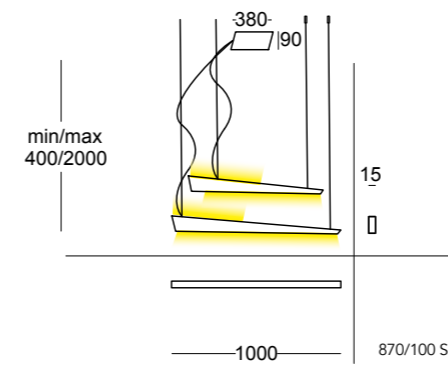



**Katana** | Suspension



White

Sandy

Matt Black

**870/200 T**

LED 5x7W + 1x4W

5500lm 3000°K upon request 2700°/4000°K

CE IP20

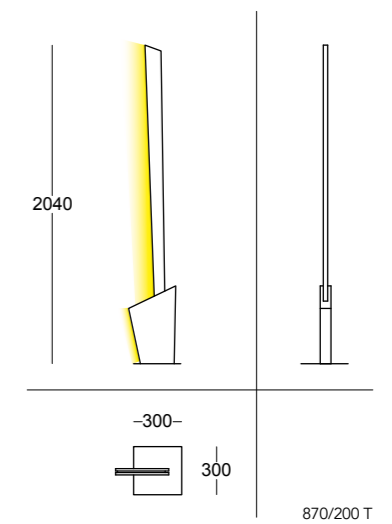

870/200 T



# Nassa

design by A. Barra

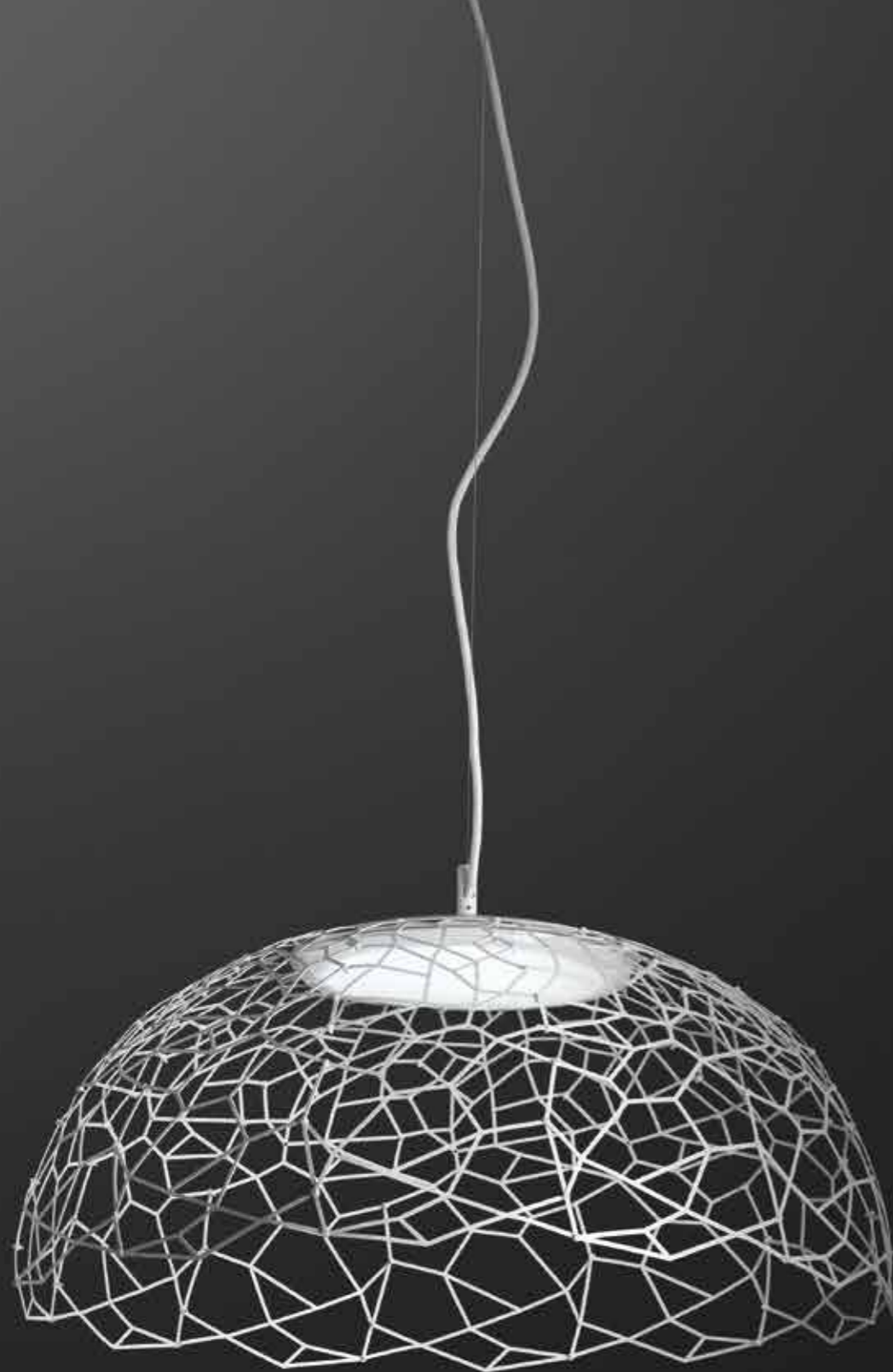

Luce eclettica, stravagante, curiosa. La sospensione perfetta per arricchire la tua stanza di originalità e innovazione. Nassa, per un'illuminazione al di fuori da ogni cliché.

Versatile, bizarre, curious light. The perfect suspension to increase the originality and innovation of your room. Nassa, for an unconventional lighting.

Licht vielseitig und kurios. Die Pendelleuchte "Nassa" ist die perfekte Leuchte um Ihren Raum durch Eleganz zu verschönern. Ihr Klischee besticht durch Originalität und Innovation.

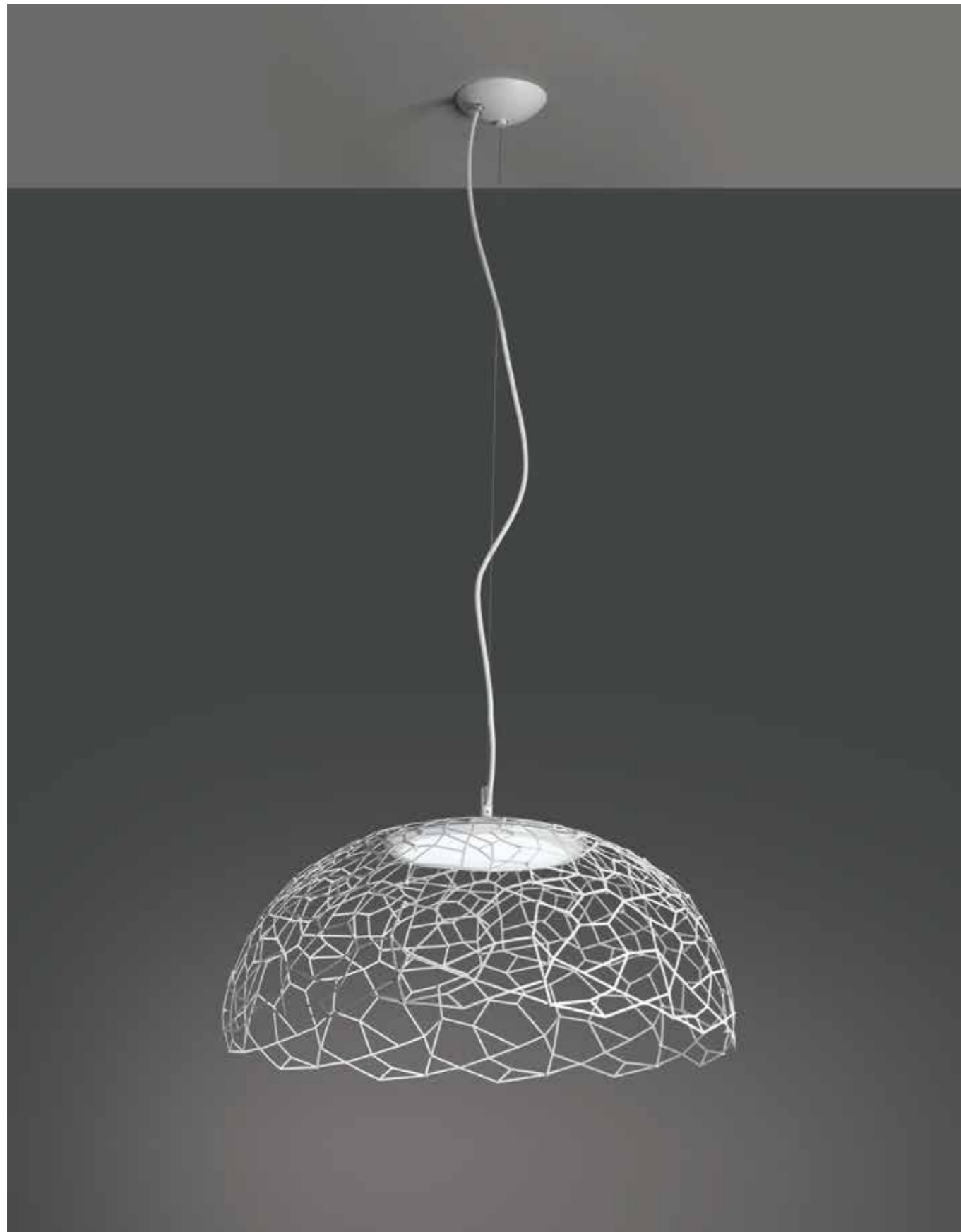

White

Sandy

Matt Black

**864/60 S**

LED 1x28W 230V  
2700lm 3000°K upon request 2700°/4000°K

CE IP20

Net weight 2500gr - Gross weight 4900gr

Volume m<sup>3</sup> 0,020

 PHASE-CUT DIMMING

**864/80 S**

LED 1x35W 230V

4000lm 3000°K upon request 2700°/4000°K

CE IP20

Net weight 4400gr - Gross weight 8700gr

Volume m<sup>3</sup> 0,037

 PHASE-CUT DIMMING

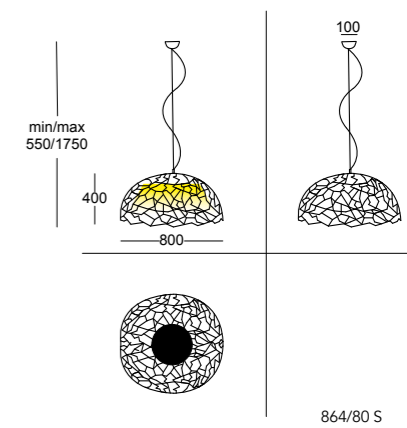
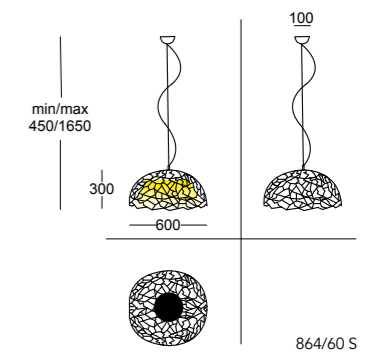

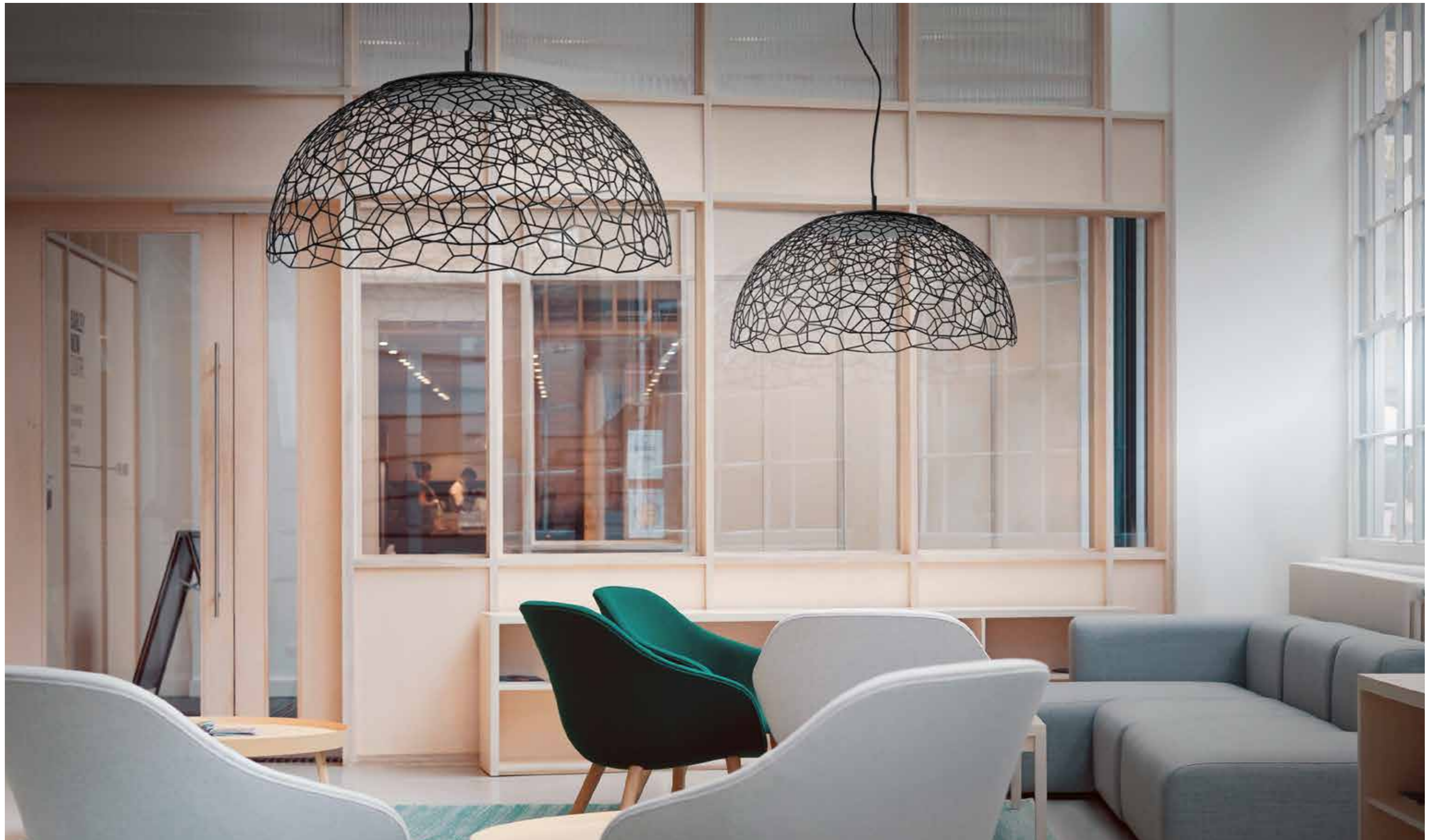





# Olimpia

design by C. Cattaneo



Olimpia, particolare ed innovativa, dispone di una testa rotante che sconvolgerà il tuo modo di illuminare. La sua forma simpatica e piacevole, la luminosità direzionale e altri curati dettagli, fanno, di questa lampada da parete o plafone, il tuo più grande desiderio.

Olimpia: peculiar and innovative. Its rotating head will stun your way of illuminating. The enjoyable and pleasant shape, the adjustable light and other well-finished details make this lamp become your utmost desire, either as wall or ceiling light.

Olimpia, spezielle und innovative, hat einen drehbaren Kopf, wird Ihre Art zur Beleuchten ändern. Seine schöne und angenehme Form, gerichtete Ausleuchtung und andere Details, tun, diese Deckenleuchte, zur Ihre größter Wunsch.

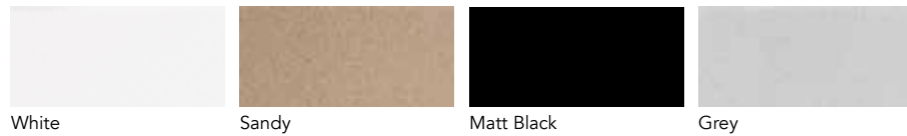

White

Sandy

Matt Black

Grey



**862/16 PA**

LED 1x15W 230V

1800lm 3000°K upon request 2700°/4000°K

CE IP20

Net weight 700gr - Gross weight 840gr

Volume m<sup>3</sup> 0,0024

 PHASE-CUT DIMMING

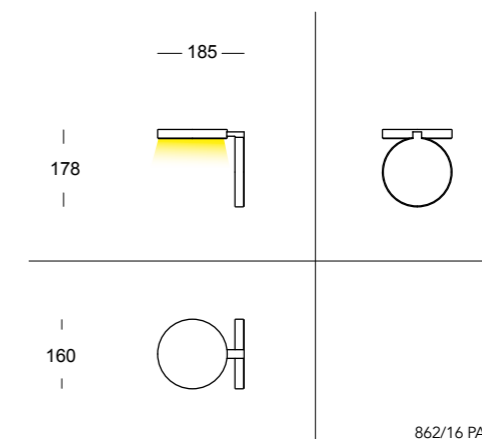

862/16 PA

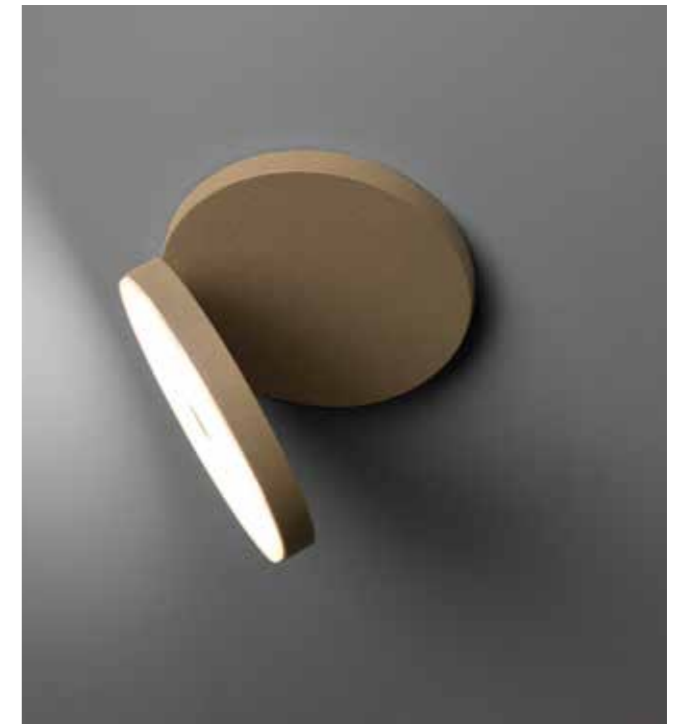





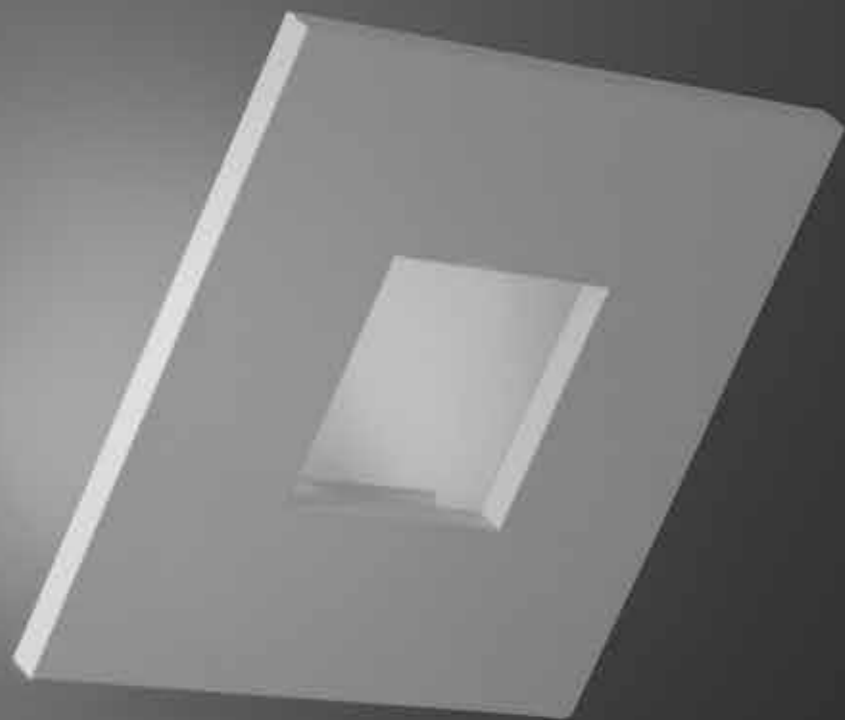

# Square

design by C. Cattaneo

Come un quadro Lampada da parete basculante in alluminio per una luce indiretta. Disponibile nelle finiture bianco, nero, grigio e sabbia.

Like a painting. Aluminum wall light, adjustable, with indirect light. Available in white, black, grey or sandy finish.

Wie ein Gemälde. Wandlampe aus Aluminium, für indirektes Licht. Erhältlich in weiß-, schwarz-, grau und sandfarben.



White

Sandy

Grey

Matt Black

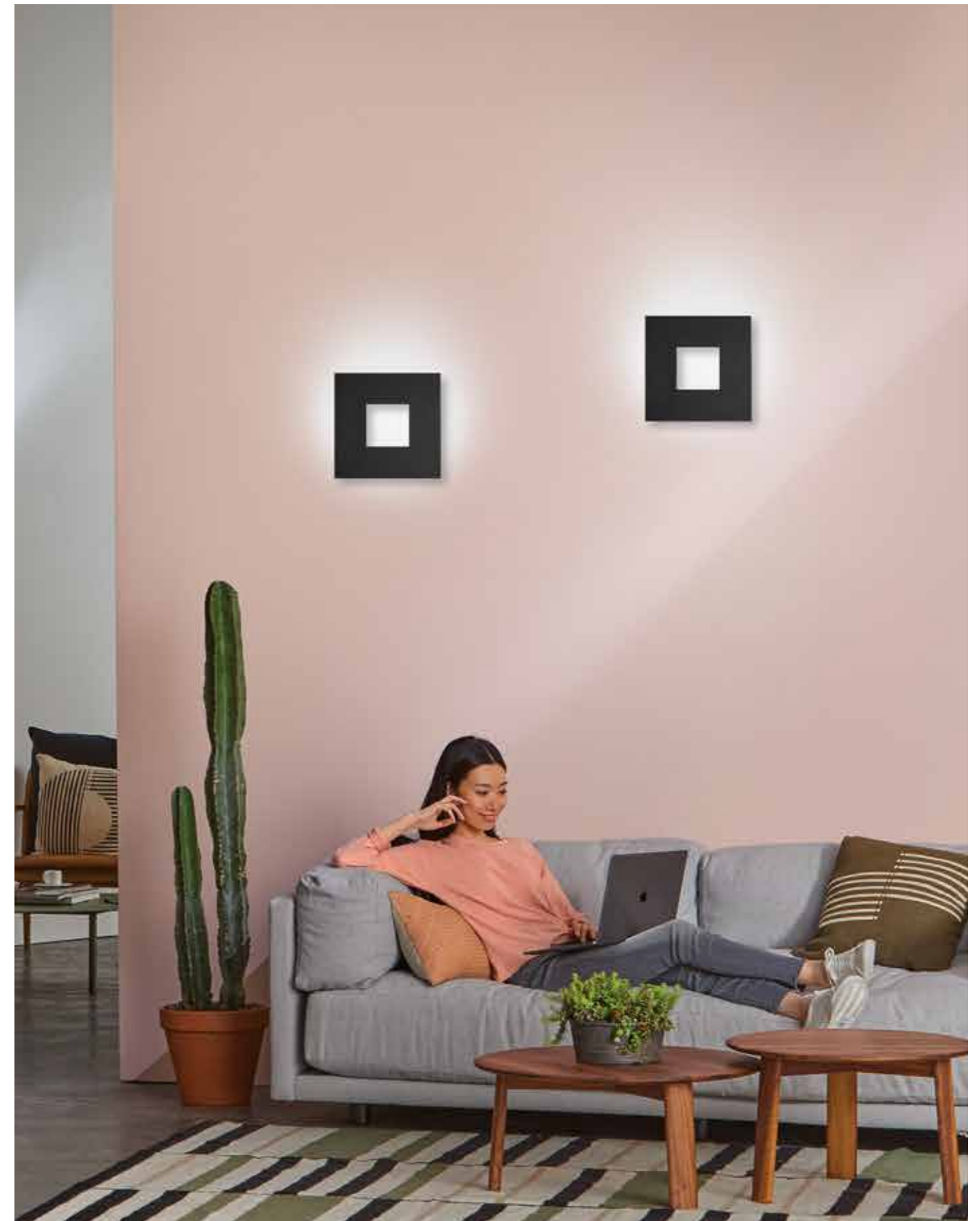







**860/20 A**  
 LED 3x8W 230V  
 2400lm 3000°K upon request 2700°/4000°K  
 CE IP20  
 Net weight 720gr - Gross weight 990gr  
 Volume m<sup>3</sup> 0,012  
 Dimmable PHASE-CUT DIMMING

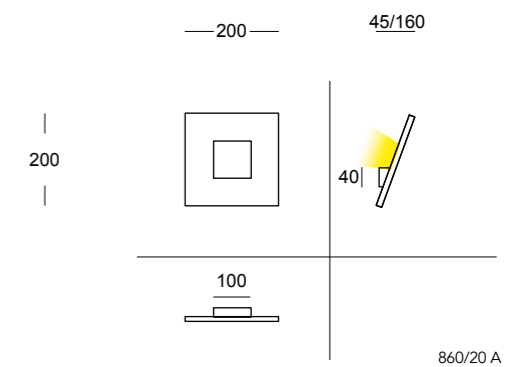

# Biquadro

design by C. Cattaneo



Lampada a sospensione di forma quadrata a luce diretta e indiretta grazie a un sistema basculante al centro della lampada.

Pendant light with a square shape and both direct and indirect light thanks to a tilting system at the centre of the lamp.

Pendeleuchte mit quadratische Form und direkt-indirekt Beleuchtung mit der Hilfe von einem Schwingsystem.





White

Sandy

Matt Black



**879/60 S**

LED 4x8W + 4x15W 230V

11200lm 3000°K upon request 2700°/4000°K

CE IP20

Net weight 7600gr - Gross weight 10500gr

Volume m<sup>3</sup> 0,090

 PHASE CUT - DIMMING

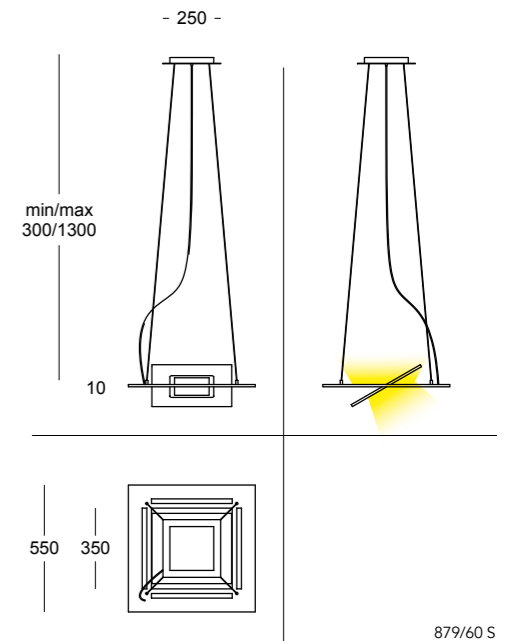

879/60 S

# Quadretto

design by E. Giudici

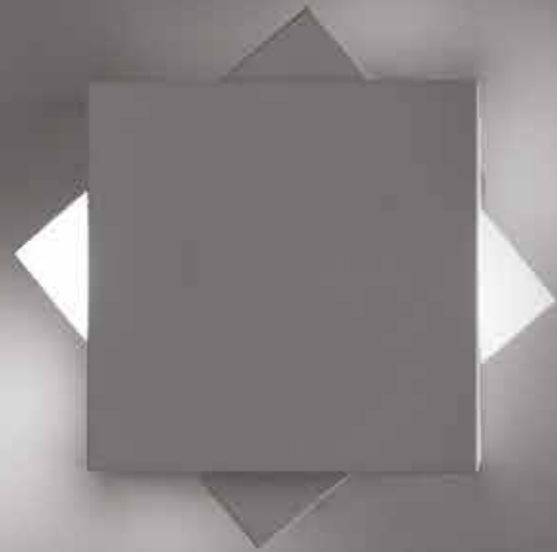

Lampada a parete in alluminio verniciato che, grazie alla sua struttura, permette giochi scenografici ed installazioni puntuali.

Wall lamp in painted aluminium. Its structure allows both punctual and scenic lighting.

Wandleuchte aus Aluminium, lackiert, dank der Struktur ermöglicht diese szenarische Spiele und eine punktuelle Installation.



White

Sandy

Grey



**761/10 A**

LED 4x2,2W 350mA 220 - 240V  
960lm 3000°K upon request 2700°/4000°K

CE IP20

Net weight 640gr - Gross weight 850gr

Volume m<sup>3</sup> 0,0047

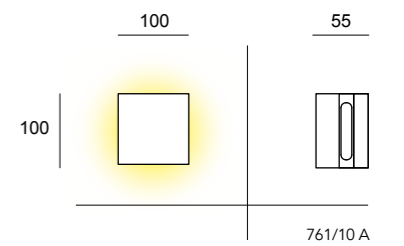

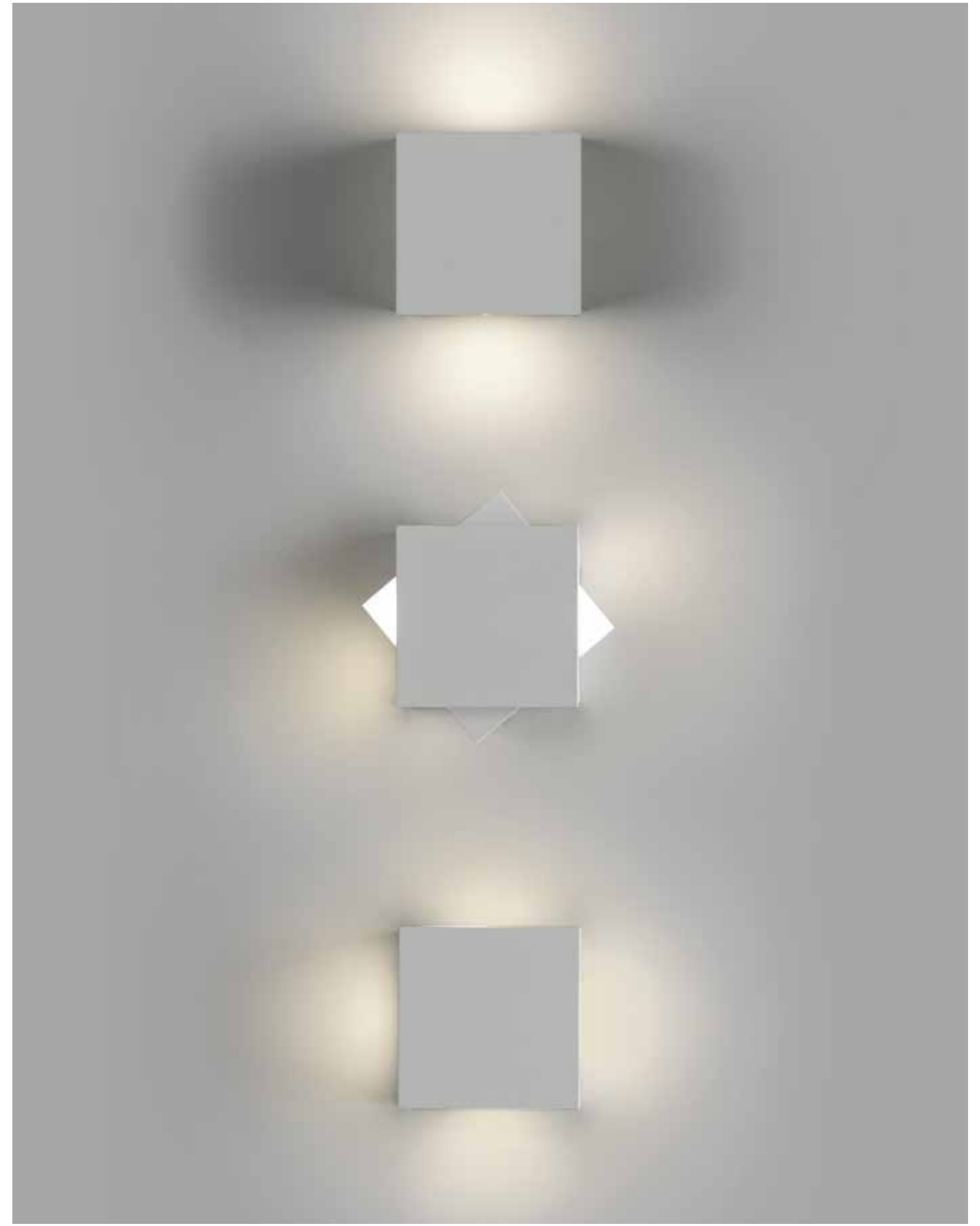

# Cubick

design by C. Cattaneo



Lampada da parete, sospensione, plafone e tavolo in metallo verniciato in diversi colori. Dal design essenziale i modelli biemissione e monomissione a parete permettono una diversa illuminazione dell'ambiente. Da oggi la versione mono emissione a parete viene integrata da un meccanismo che consente di ruotare la lampada a seconda delle esigenze funzionali.

Wall lights, pendant lights, ceiling lights and table lights in metal, painted in several finishes. With an essential design, double and mono emission models give the chance to enlighten the environment in different ways. The mono emission variation has now been equipped with a mechanism that allows to rotate the fitting according to any functional need.

Wandlampe, Hängelampe, Deckenleuchte und Tischleuchte aus lackiertem Metall in verschiedenen Farben. Mit ihrem wesentlichen Design ermöglichen die Modelle Bi-emission und Wandaufbau Monomission eine unterschiedliche Umgebungsbeleuchtung. Ab sofort wird die Single-Emissions-Wandversion durch einen Mechanismus ergänzt, mit dem Sie die Lampe nach funktionalen Bedürfnissen drehen können.



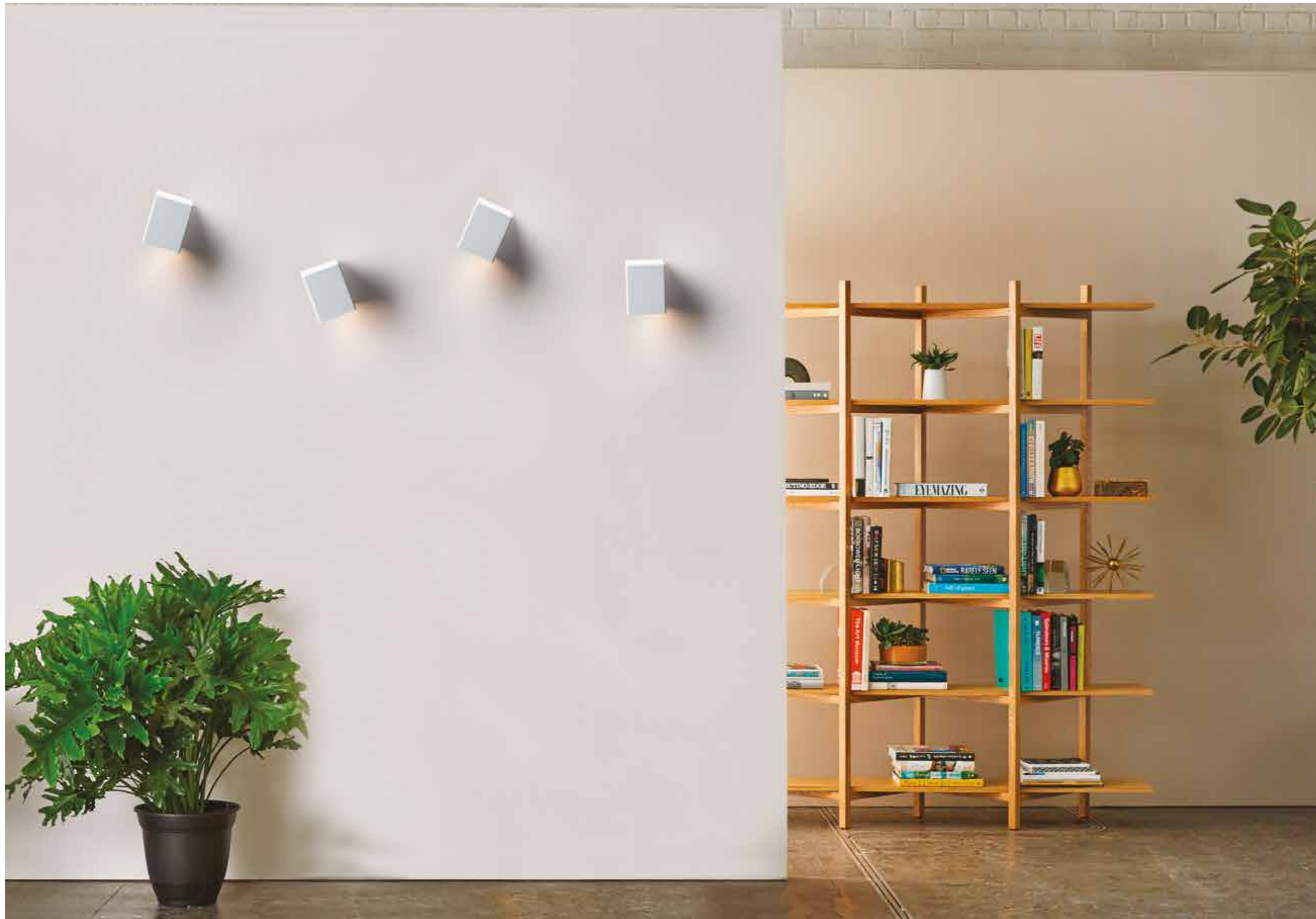



White

Sandy

Grey



**899/5 A**

LED 1×4,5W 230V  
 380lm 3000°K upon request 2700°/4000°K  
 CE IP20  
 Net weight 290gr - Gross weight 470gr  
 Volume m<sup>3</sup> 0,0044

 PHASE-CUT DIMMING

**899/7 A**

LED 1×8,7W 230V  
 740lm 3000°K upon request 2700°/4000°K  
 CE IP20  
 Net weight 470gr - Gross weight 650gr  
 Volume m<sup>3</sup> 0,0044

 PHASE-CUT DIMMING



**899/9 A**

LED 1×13W 230V  
 1140lm 3000°K upon request 2700°/4000°K  
 CE IP20  
 Net weight 660gr - Gross weight 960gr  
 Volume m<sup>3</sup> 0,0092

 PHASE-CUT DIMMING

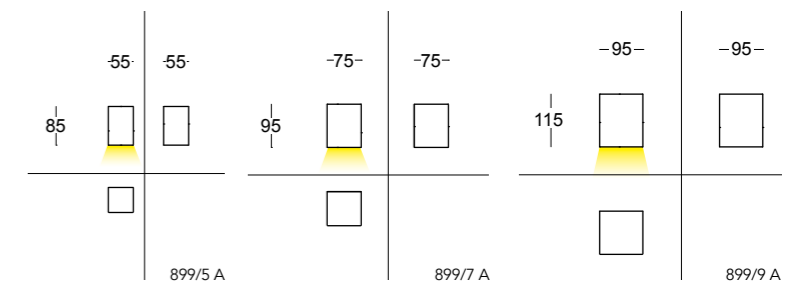



White

Sandy

Grey

**767/5 A**

LED 2×4,5W

760lm 3000°K upon request 2700°/4000°K

CE IP20

Net weight 300gr - Gross weight 490gr

Volume m<sup>3</sup> 0,0047

 PHASE-CUT DIMMING

**767/7 A**

LED 2×8,7W

1480lm 3000°K upon request 2700°/4000°K

CE IP20

Net weight 490gr - Gross weight 670gr

Volume m<sup>3</sup> 0,0047

 PHASE-CUT DIMMING

**767/9 A**

LED 1×13W

2280lm 3000°K upon request 2700°/4000°K

CE IP20

Net weight 820gr - Gross weight 1060gr

Volume m<sup>3</sup> 0,0090

 PHASE-CUT DIMMING

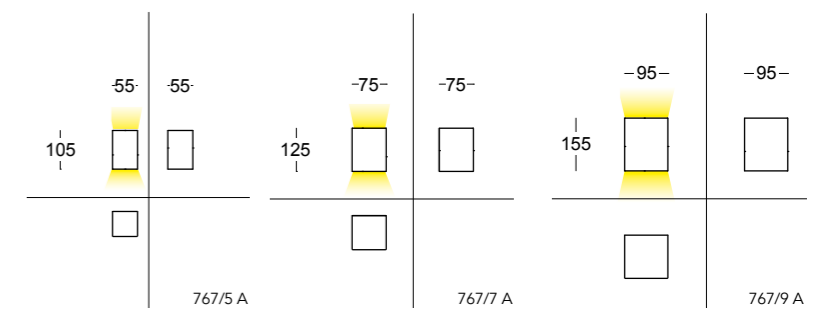



**768/5 P**

LED 1x4,5W 230V  
380lm - 3000°K upon request 2700°/4000°K

CE IP20  
Net weight 190gr - Gross weight 380gr  
Volume m<sup>3</sup> 0,0047

PHASE-CUT DIMMING

**768/7 P**

LED 1x8,7W 230V  
740lm - 3000°K upon request 2700°/4000°K

CE IP20  
Net weight 330gr - Gross weight 510gr  
Volume m<sup>3</sup> 0,0047

PHASE-CUT DIMMING

**768/9 P**

LED 1x13W 230V  
1140lm - 3000°K upon request 2700°/4000°K

CE IP20  
Net weight 570gr - Gross weight 870gr  
Volume m<sup>3</sup> 0,0090

PHASE-CUT DIMMING

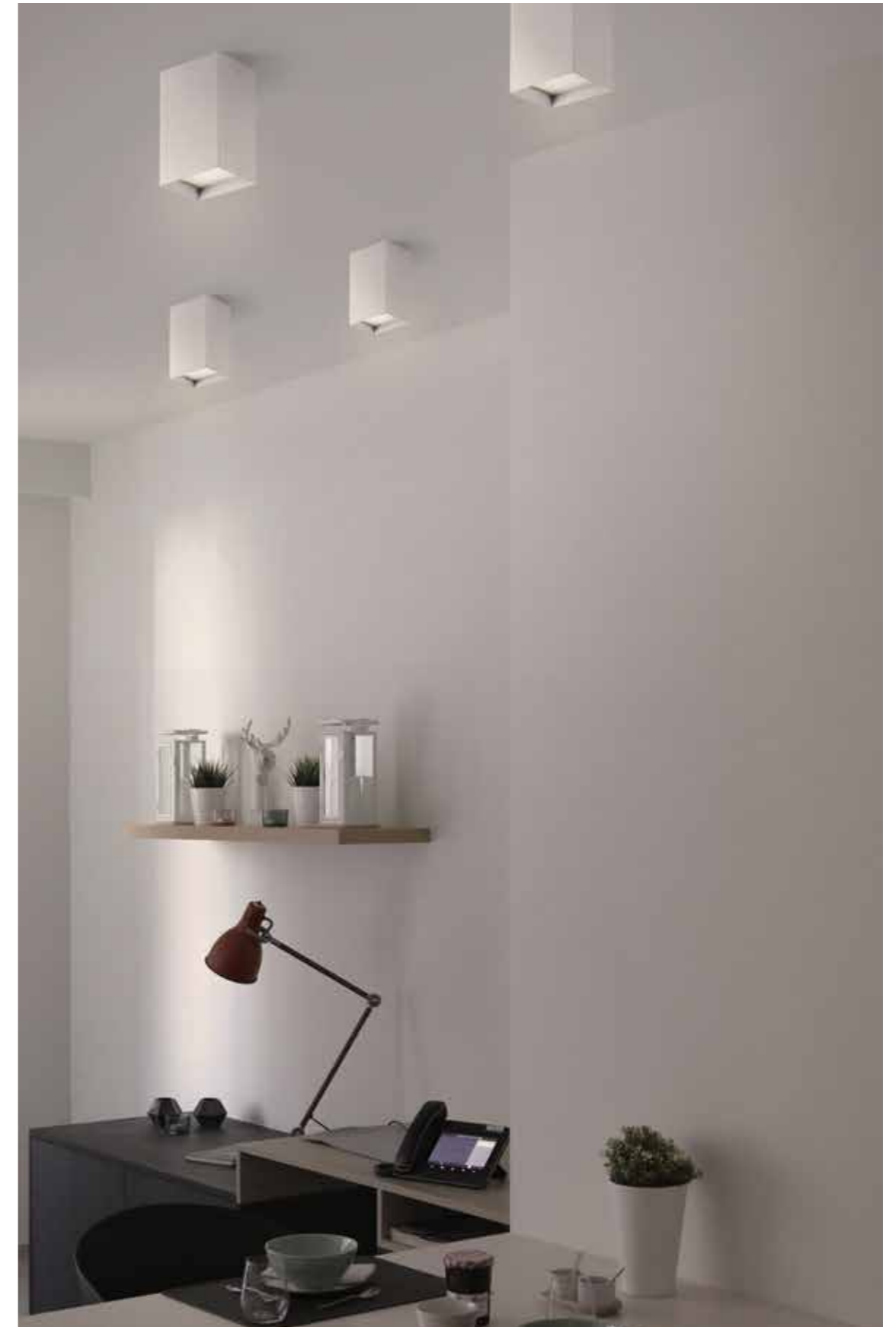
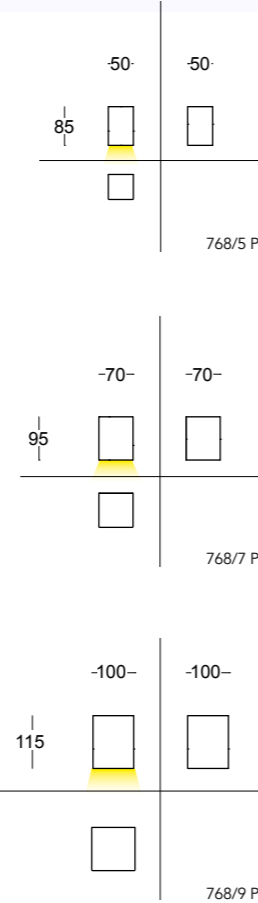



White

Sandy

Grey



**768/5 S**

LED 1×4,5W 230V  
 380lm - 3000°K upon request 2700°/4000°K  
 CE IP20  
 Net weight 380gr - Gross weight 550gr  
 Volume m<sup>3</sup> 0,0047  
 Dimmable PHASE-CUT DIMMING

**768/7 S**

LED 1×8,7W 230V  
 740lm 3000°K upon request 2700°/4000°K  
 CE IP20  
 Net weight 460gr - Gross weight 630gr  
 Volume m<sup>3</sup> 0,0047  
 Dimmable PHASE-CUT DIMMING

**768/9 S**

LED 1×13W 230V  
 1140lm 3000°K upon request 2700°/4000°K  
 CE IP20  
 Net weight 730gr - Gross weight 1000gr  
 Volume m<sup>3</sup> 0,0090  
 Dimmable PHASE-CUT DIMMING

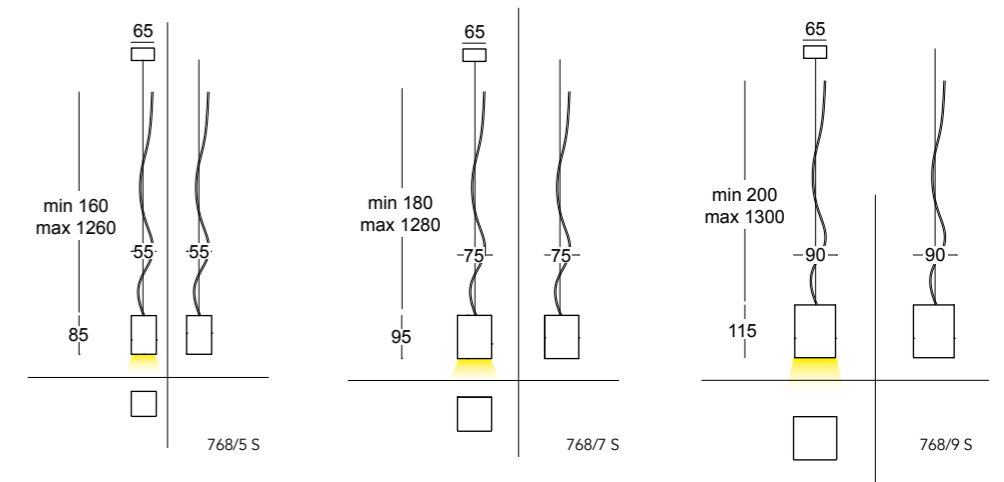

768/5 S

768/7 S

768/9 S

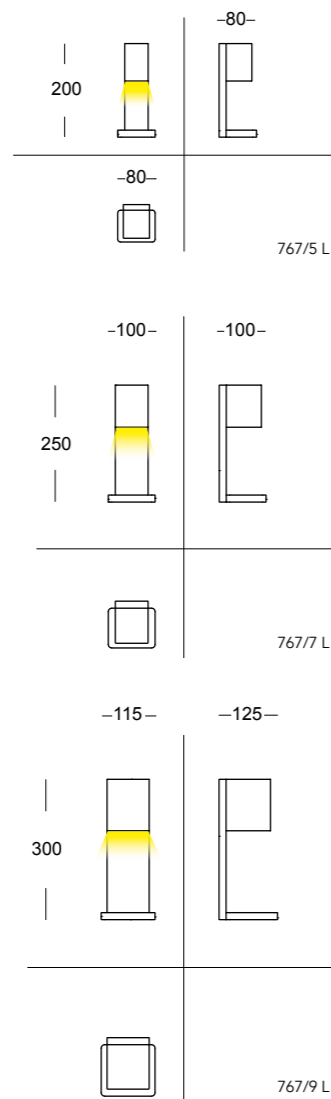

**767/5 L**

1x4,5W 230V  
 380lm - 3000°K upon request 2700°/4000°K  
 CE Ⓢ IP20  
 Net weight 500gr - Gross weight 680gr  
 Volume m<sup>3</sup> 0,0047

**767/7 L**

1x8,7W 230V  
 740lm - 3000°K upon request 2700°/4000°K  
 CE Ⓢ IP20  
 Net weight 840gr - Gross weight 1180gr  
 Volume m<sup>3</sup> 0,0090

**767/9 L**

1x13W 230V  
 1140lm - 3000°K upon request 2700°/4000°K  
 CE Ⓢ IP20  
 Net weight 1090gr - Gross weight 1600gr  
 Volume m<sup>3</sup> 0,042



# Tratto

design by C. Cattaneo

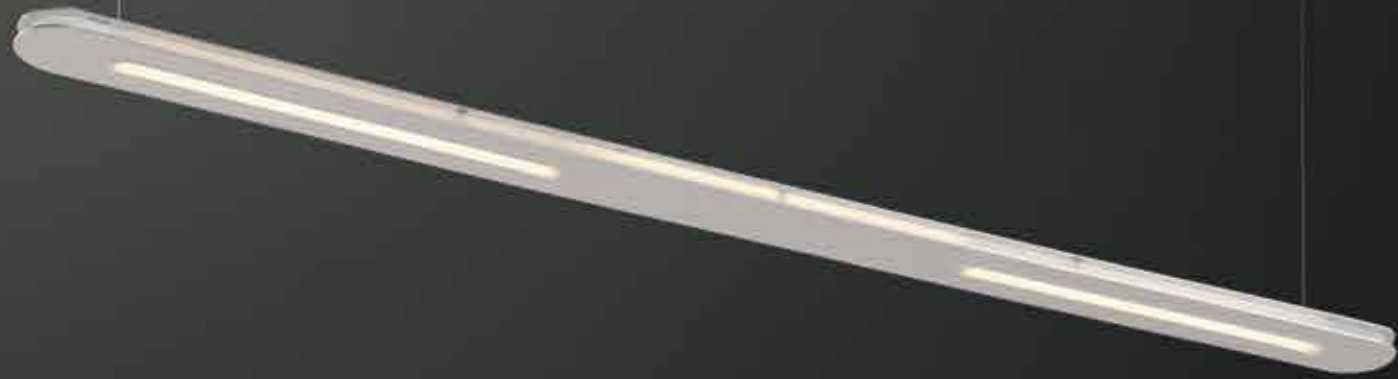

Lampade da parete in metallo verniciato e polycarbonato. Grazie alla sua struttura, Tratto offre un'illuminazione sia d'ambiente sia scenografica proiettando sulle pareti giochi di luce che possono essere cambiati in funzione al montaggio dell'apparecchio.

Wall lights in painted metal and polycarbonate. Thanks to its structure, Tratto offers an ambient light as well as a scenographic light projecting on the walls plays of light that can be adjusted at installation.

Wandleuchten aus lackiertem Metall und Polycarbonat. Aufgrund seiner Struktur, bietet Tratto eine Beleuchtung des Ambientes, es werden an die Waende Lichtspiele projiziert, welche durch eine variable Montage des Gerätes, verändert werden können.



White

Sandy

Grey



**754/90 S**

3x15W 24V 220-240 V

6000lm 3000°K upon request 2700°/4000°K

CE IP20

Net weight 2650gr - Gross weight 4200gr

Volume m<sup>3</sup> 0,022

 with leading edge or trailing edge dimmer

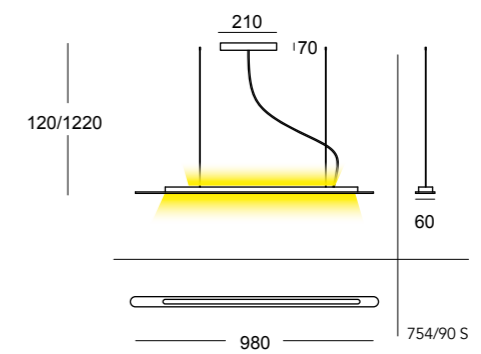



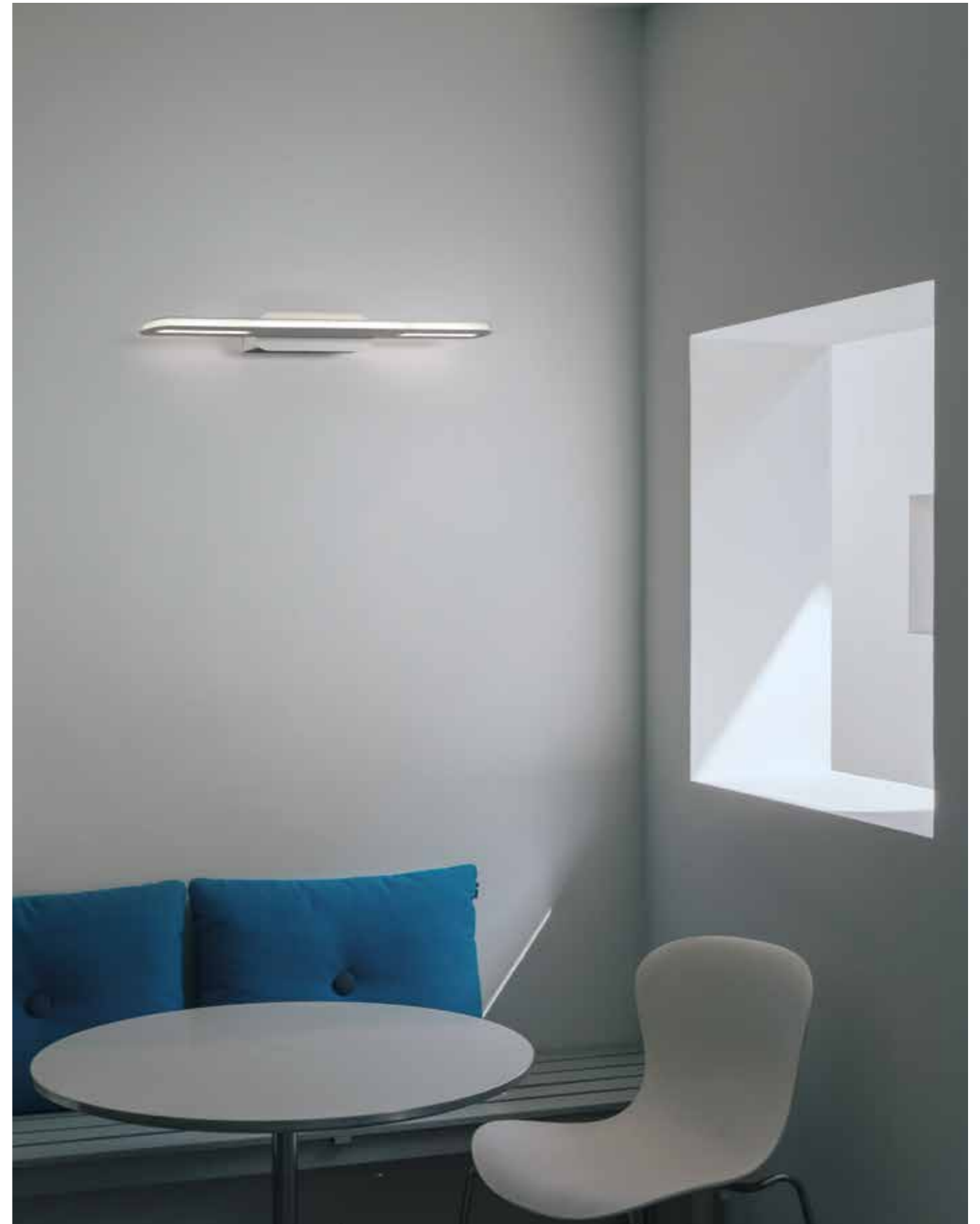



Tratto | Wall

**754/60A | 754/60A IP\*** | Bi-emissione

LED 2x15W 220 - 240V

4000lm - 3000°K upon request 2700°/4000°K

\*High Protection IP44

CE IP20

Net weight 2150gr - Gross weight 2550gr

Volume m<sup>3</sup> 0,013

**754/90A | 754/90A IP\*** | Bi-emissione

LED 3x15W 24V 220-240 V

6000lm 3000°K upon request 2700°/4000°K

\*High Protection IP44

CE IP20

Net weight 2720gr - Gross weight 3490gr

Volume m<sup>3</sup> 0,022

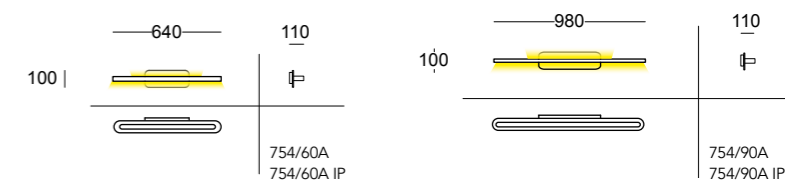



**754/30A | 754/30A IP\*** | Mono-emissione  
 LED 1x15W 220 - 240V  
 2000 lm - 3000°K upon request 2700°/4000°K  
 \*High Protection IP44  
 CE IP20  
 Net weight 960gr - Gross weight 1330gr  
 Volume m<sup>3</sup> 0,013

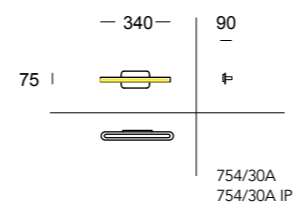

**774/60A | 774/60A IP\*** | Mono-emissione  
 LED 2x15W 220 - 240V  
 4000lm - 3000°K upon request 2700°/4000°K  
 \*High Protection IP44  
 CE IP20  
 Net weight 2150gr - Gross weight 2550gr  
 Volume m<sup>3</sup> 0,013

**774/90A | 774/90A IP\*** | Mono-emissione  
 LED 3x15W 220 - 240V  
 6000lm - 3000°K upon request 2700°/4000°K  
 \*High Protection IP44  
 CE IP20  
 Net weight 2720gr - Gross weight 3490gr  
 Volume m<sup>3</sup> 0,022

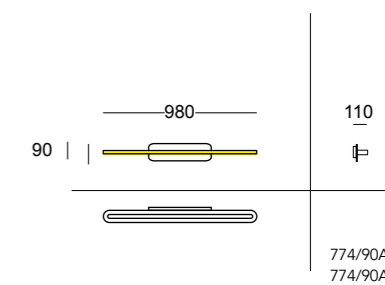
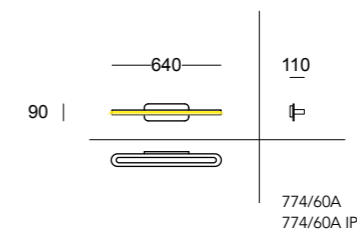



White

Sandy

Grey



**754/30 PA | 754/30 PA IP\***  
 LED 1x15W 24V Dc 220 - 240V  
 2000lm - 3000°K upon request 2700°/4000°K  
 \*High Protection IP44  
 CE IP20  
 Net weight 900gr - Gross weight 1200gr  
 Volume m<sup>3</sup> 0,013

**754/60 PA | 754/60 PA IP\***  
 LED 2x15W 24V Dc 220 - 240V  
 4000 lm - 3000°K upon request 2700°/4000°K  
 \*High Protection IP44  
 CE IP20  
 Net weight 2050gr - Gross weight 2550gr  
 Volume m<sup>3</sup> 0,013

**754/90 PA | 754/90 PA IP\***  
 LED 3x15W 24V Dc 220 - 240V  
 6000 lm - 3000°K upon request 2700°/4000°K  
 \*High Protection IP44  
 CE IP20  
 Net weight 3080gr - Gross weight 3570gr  
 Volume m<sup>3</sup> 0,022

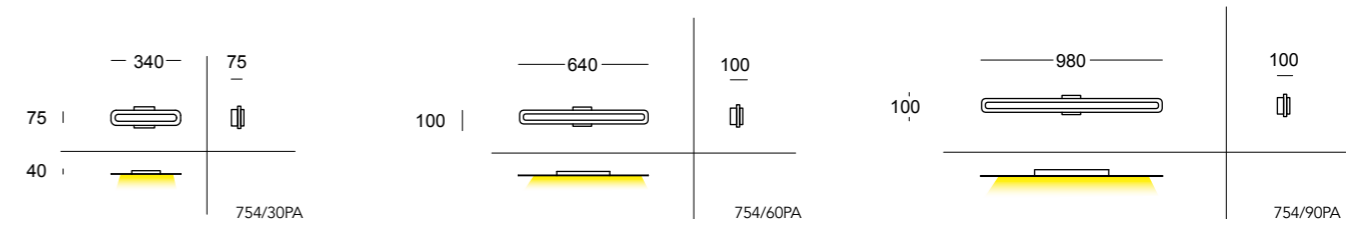

754/30PA

754/60PA

754/90PA

# Abbraccio

design by C. Cattaneo



Lampada a parete semplice nella linea e funzionale nell' utilizzo. Grazie alla sua struttura magnetica permette una facile manutenzione.

Wall lamp with a simple outline and functional use. Its built-in magnetic system allows easy maintenance operations.

Stilistisch einfache und lineare Wandleuchte mit im Gebrauch funktioneller Bedienung. Aufgrund der magnetischen Struktur ermöglicht diese eine einfache Wartung.



White

Sandy

Grey

Matt Black

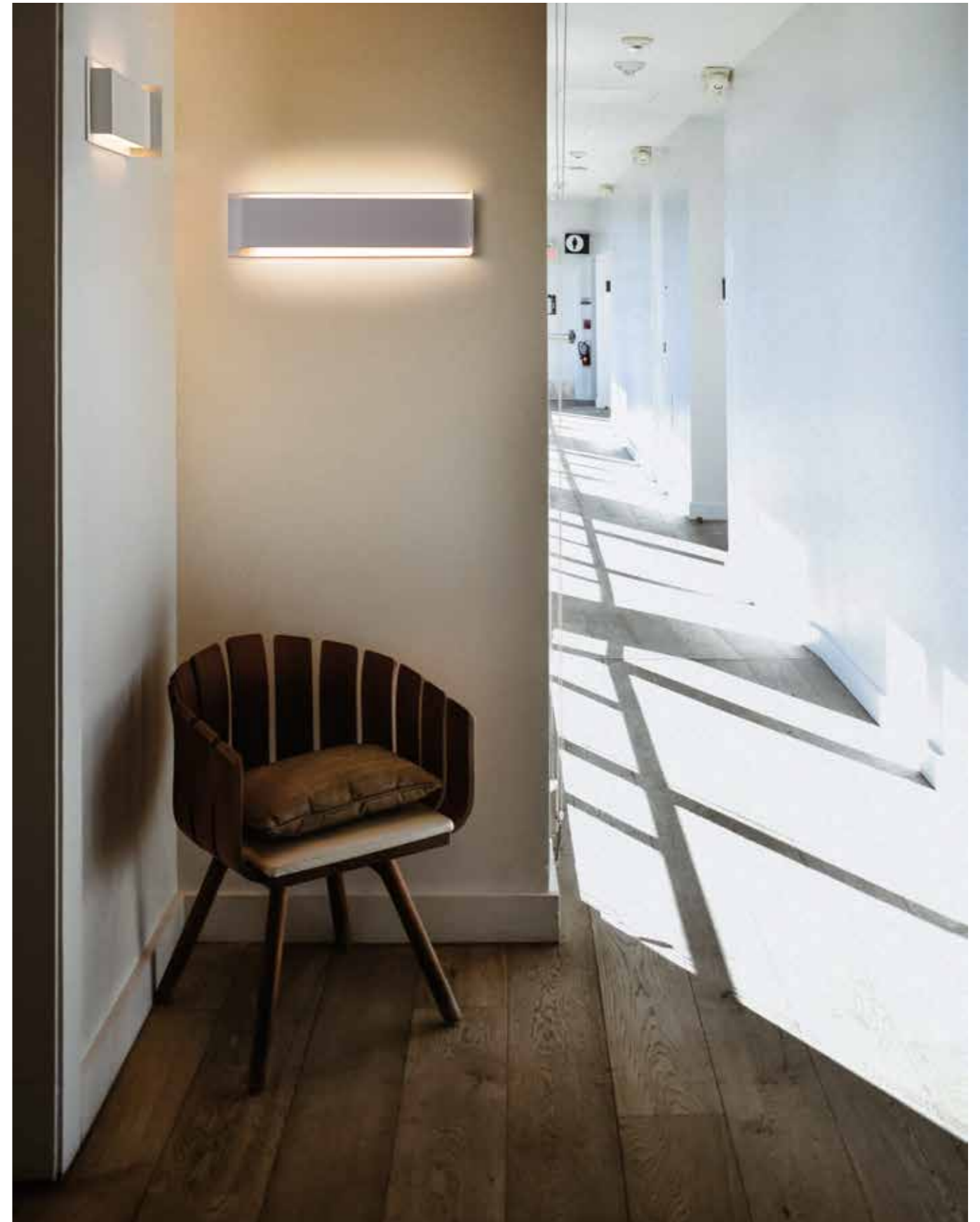



**770/21 A**  
 LED 2x6W 24V Dc 220 - 240V  
 1600lm 3000°K upon request 2700°/4000°K  
 CE  $\oplus$  IP20  
 Net weight 710gr - Gross weight 880gr  
 Volume m<sup>3</sup> 0,0047

**770/36 A**  
 LED 2x12W 24V Dc 220 - 240V  
 3200lm 3000°K upon request 2700°/4000°K  
 CE  $\oplus$  IP20  
 Net weight 1150gr - Gross weight 1600gr  
 Volume m<sup>3</sup> 0,050

**770/70 A**  
 LED 4x12W 24V Dc 220 - 240V  
 6400lm 3000°K upon request 2700°/4000°K  
 CE  $\oplus$  IP20  
 Net weight 2150gr - Gross weight 2570gr  
 Volume m<sup>3</sup> 0,012

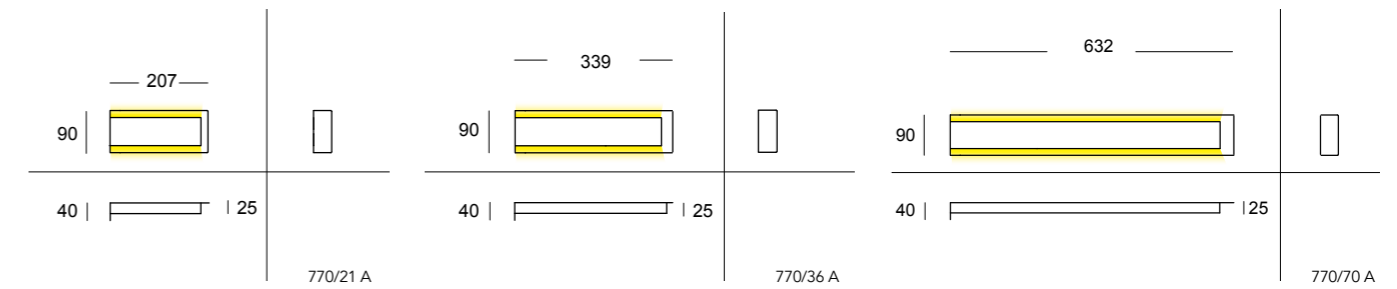



# Bolle

design by C. Cattaneo

Lampada da soffitto e da sospensione in metallo verniciato con misure e forme diverse. Grazie alla sua struttura permette sia una illuminazione puntuale e scenografica.

Ceiling and suspended lamps in painted metal. Available in different sizes and shapes, for punctual and scenic lighting.

Decken- und Haengelampe aus Metall, lackiert in diversen Groessen und Formen. Dank ihrer Struktur bietet sie Punkt- und Szenenbeleuchtung.





White

Sandy

Grey



**755/30 S**

LED 1x17W 220 - 240V  
1500lm - 3000°K upon request 2700°/4000°K

CE IP20

Net weight 1905gr - Gross weight 3505gr

Volume m<sup>3</sup> 0,031

Dimmable PHASE-CUT DIMMING

**755/60 S**

LED 3x17W 230V  
4500lm - 3000°K upon request 2700°/4000°K

CE IP20

Net weight 7700gr - Gross weight 10800gr

Volume m<sup>3</sup> 0,078

Dimmable PHASE-CUT DIMMING

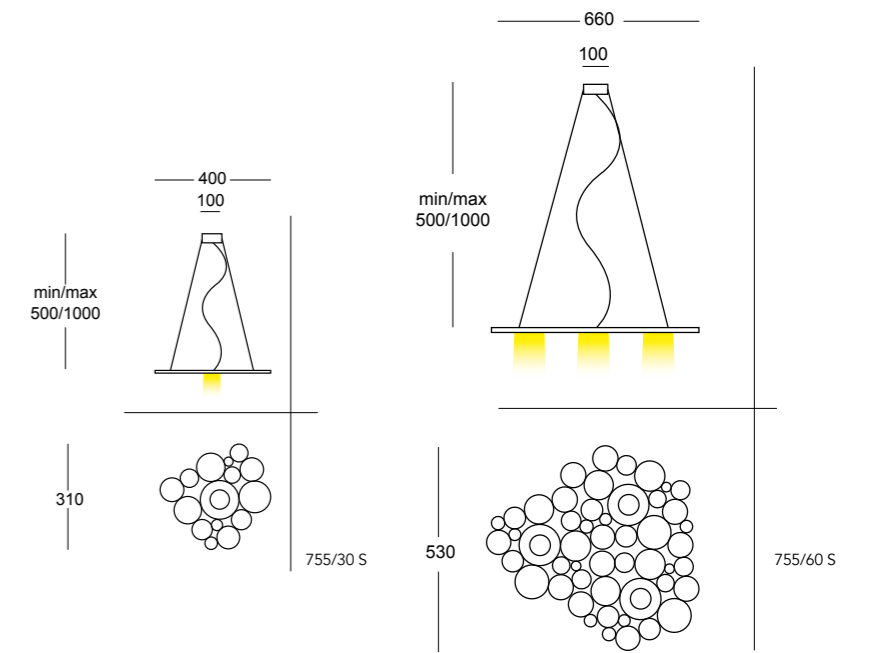



White

Sandy

Grey



**755/30 PA**

LED 1x17W 220 - 240V

1500lm - 3000°K upon request 2700°/4000°K

CE IP20

Net weight 1905gr - Gross weight 3505gr

Volume m<sup>3</sup> 0,031

Dimmable PHASE-CUT DIMMING

**755/60 PA**

LED 3x17W 230V

4500lm - 3000°K upon request 2700°/4000°K

CE IP20

Net weight 7700gr - Gross weight 10800gr

Volume m<sup>3</sup> 0,078

Dimmable PHASE-CUT DIMMING

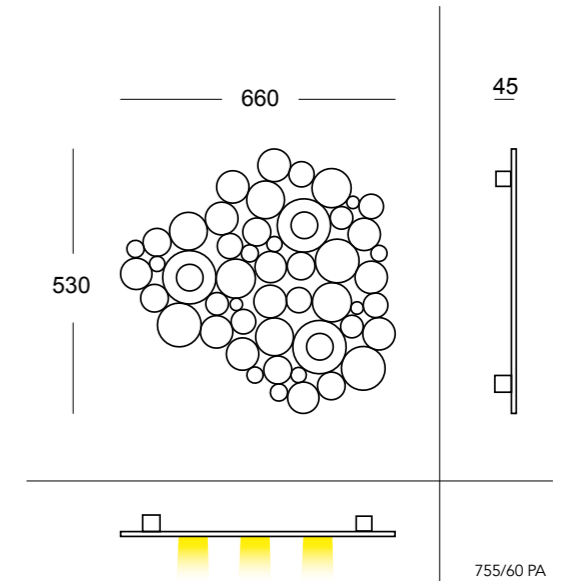
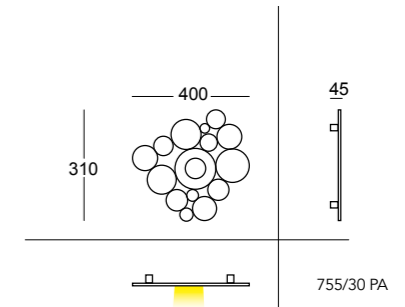

# Fuorisquadra

design by C. Cattaneo

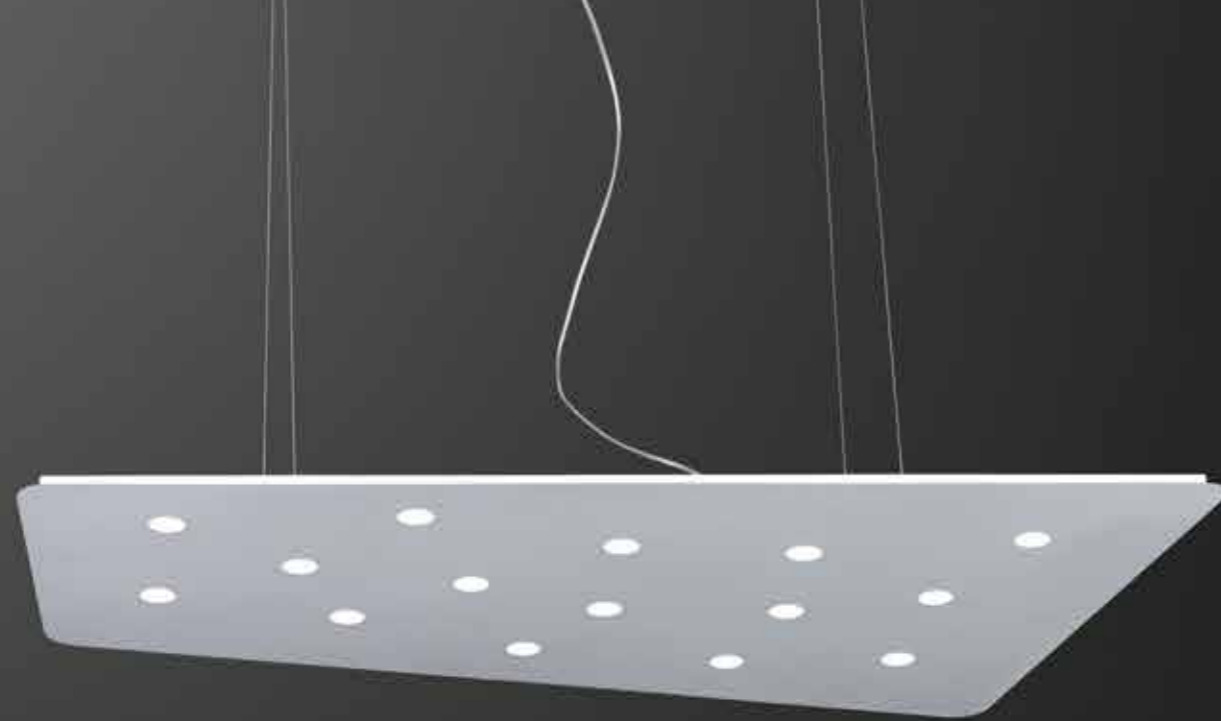

Lampada da soffitto formata da una lastra di metallo sottilissimo di varie dimensioni con un meccanismo innovativo per la manutenzione.

Ceiling lamp featuring a very thin metal plate available in different sizes. An innovative magnetic system allows easy maintenance operations.

Deckelampe mit einer dünnen Metallplatte in verschiedenen Größen, ausgestattet mit einem innovativen Mechanismus fuer eine unproblematische Wartung durch das System "Push".

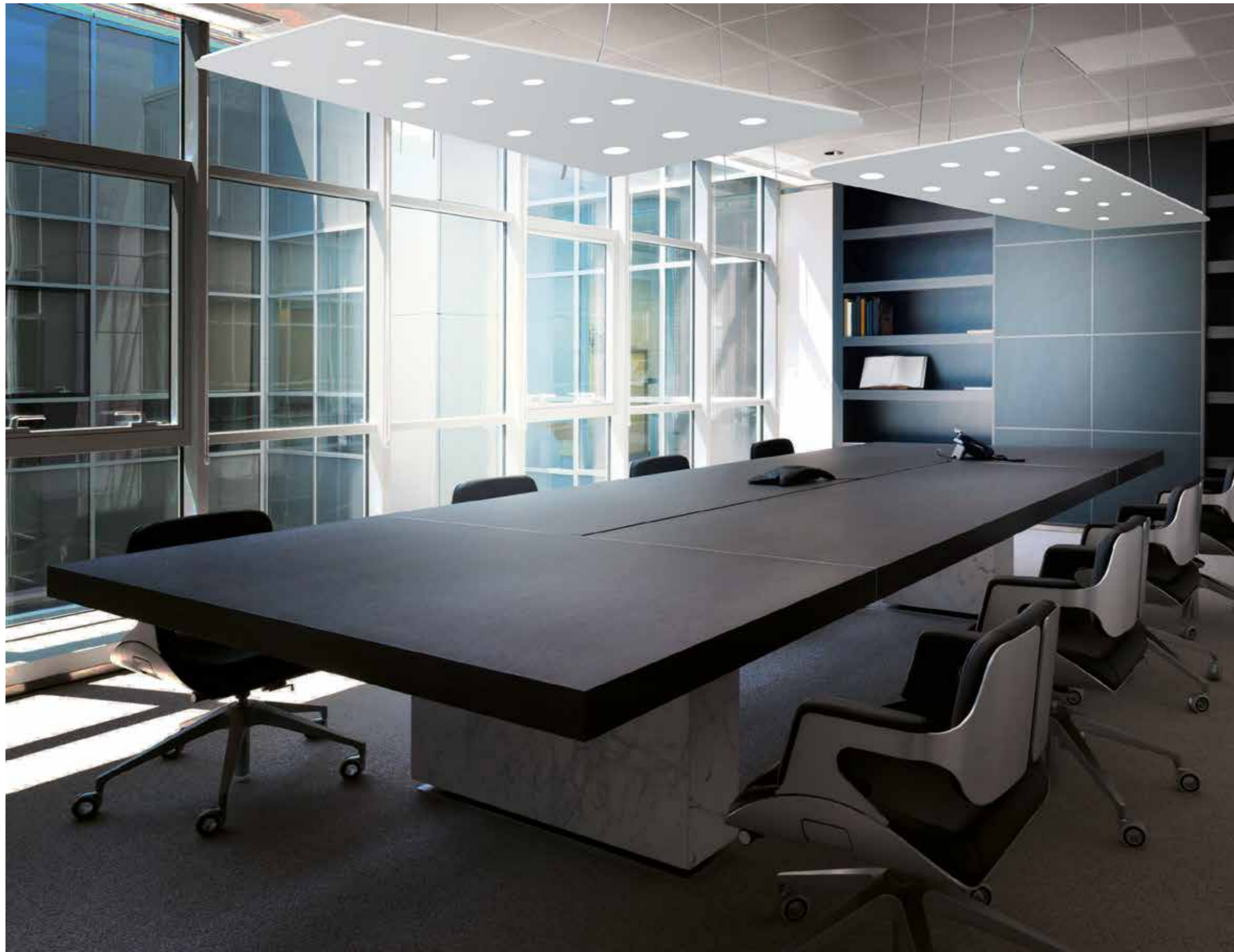

White

Sandy

Grey

**764/50 S**

LED 230V  
3040 + 760lm 3000°K upon request 2700°/4000°K

CE IP20

Net weight 4600gr - Gross weight 6700gr

Volume m<sup>3</sup> 0,0047

Dimmable PHASE-CUT DIMMING

**764/64 S**

LED 230V  
4560+1140lm 3000°K upon request 2700°/4000°K

CE IP20

Net weight 8920gr - Gross weight 10010gr

Volume m<sup>3</sup> 0,0077

Dimmable PHASE-CUT DIMMING

**764/100 S**

LED 230V  
5700+1520lm 3000°K upon request 2700°/4000°K

CE IP20

Net weight 11500gr - Gross weight 14200gr

Volume m<sup>3</sup> 0,133

Dimmable PHASE-CUT DIMMING

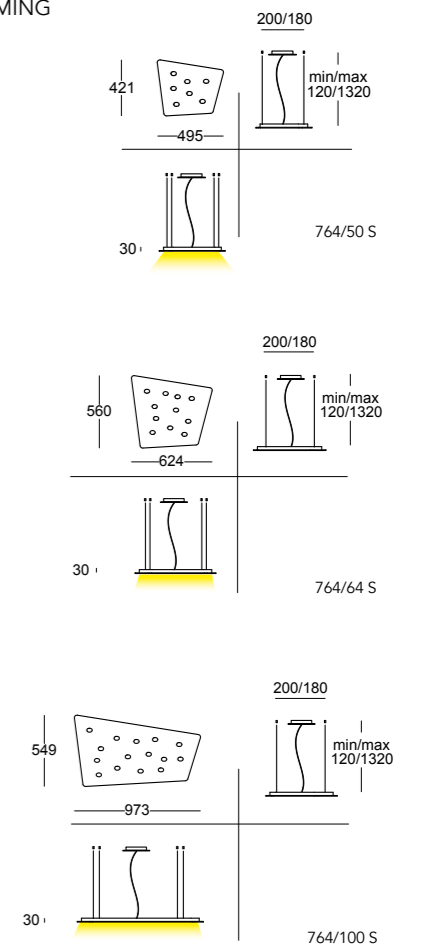



White

Sandy

Grey

**764/25 PA**

760lm - 3000°K upon request 2700°/4000°K

CE IP20

Net weight 1010gr - Gross weight 1420gr

Volume m<sup>3</sup> 0,014

 PHASE-CUT DIMMING

**764/35 PA**

1900lm - 3000°K upon request 2700°/4000°K

CE IP20

Net weight 1950gr - Gross weight 2760gr

Volume m<sup>3</sup> 0,020

 PHASE-CUT DIMMING

**764/50 PA**

3040lm - 3000°K upon request 2700°/4000°K

CE IP20

Net weight 4900gr - Gross weight 5700gr

Volume m<sup>3</sup> 0,047

 PHASE-CUT DIMMING

**764/64 PA**

4560lm - 3000°K upon request 2700°/4000°K

CE IP20

Net weight 8100gr - Gross weight 9300gr

Volume m<sup>3</sup> 0,077

 PHASE-CUT DIMMING

**764/100 PA**

5700lm - 3000°K upon request 2700°/4000°K

CE IP20

Net weight 10800gr - Gross weight 13400gr

Volume m<sup>3</sup> 0,14

 PHASE-CUT DIMMING

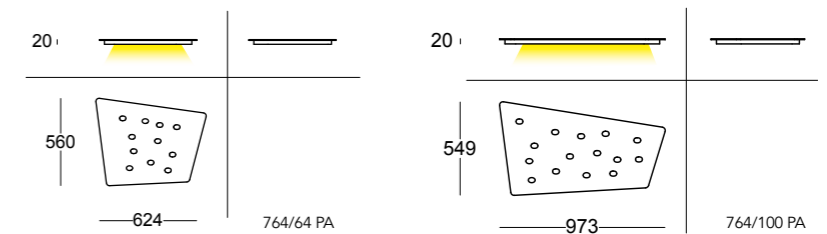
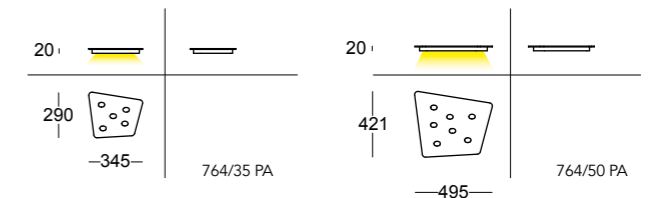
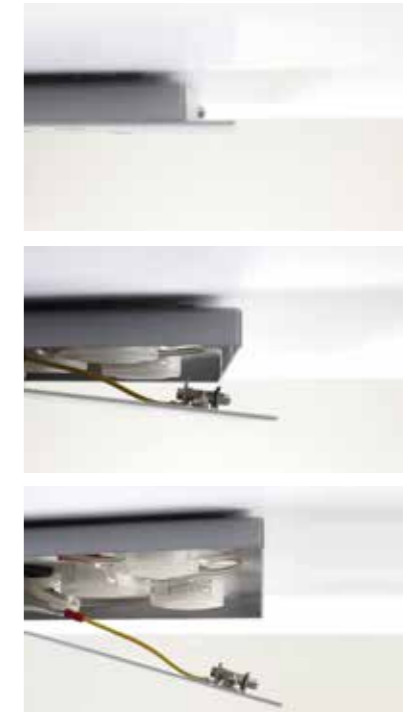

# Biscotto

design by C. Cattaneo



Lampada da soffitto e da sospensione in metallo verniciato in vari colori con all'interno punti luce a led per un risparmio energetico.

Ceiling and suspended lamps in painted metal. Available in different colours. Led lights allow energy saving.

Eine Lampe als Decken- oder Haengelampe aus Metall, lackiert in diversen Farben mit eingelegten LED Punkten zur Energieeinsparung.



White

Sandy

Grey



**765/100 S**

LED 5+2x4,5W 230V

1900+760lm - 3000°K upon request 2700°/4000°K

CE IP20

Net weight 2650gr - Gross weight 3870gr

Volume m<sup>3</sup> 0,022

 PHASE-CUT DIMMING

**765/130 S**

LED 7+2x4,5W 230V

2660+760lm - 3000°K upon request 2700°/4000°K

CE IP20

Net weight 4200gr - Gross weight 5500gr

Volume m<sup>3</sup> 0,046

 PHASE-CUT DIMMING

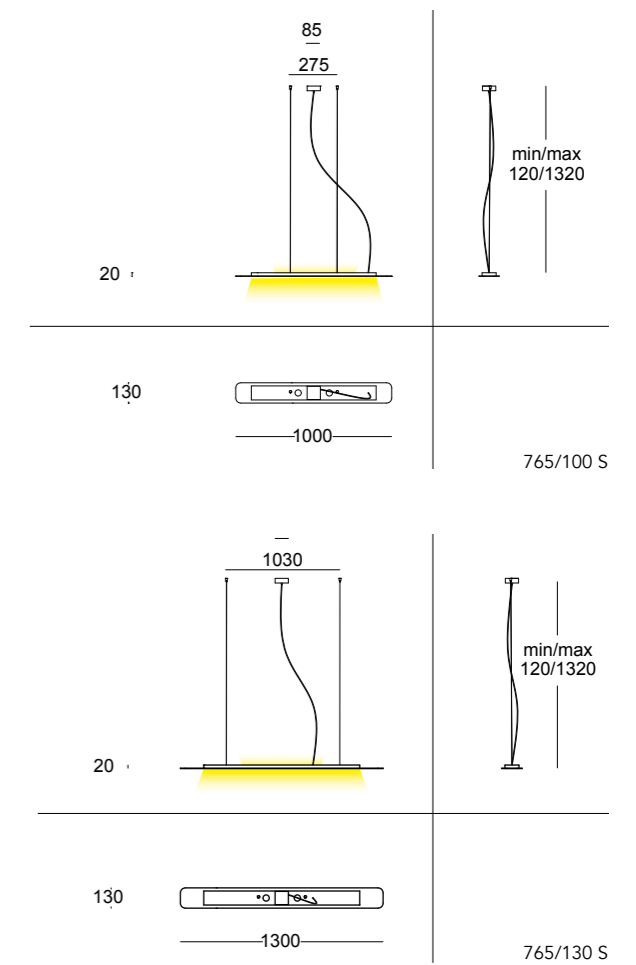



#### 765/60 PA

LED 4x4,5W 230V  
 1520lm - 3000°K upon request 2700°/4000°K  
 CE IP20  
 Net weight 1620gr - Gross weight 2340gr  
 Volume m<sup>3</sup> 0,013  
 Dimmable PHASE-CUT DIMMING

#### 765/100 PA

LED 5x4,5W 230V  
 1900lm - 3000°K upon request 2700°/4000°K  
 CE IP20  
 Net weight 2450gr - Gross weight 3780gr  
 Volume m<sup>3</sup> 0,022  
 Dimmable PHASE-CUT DIMMING

#### 765/130 PA

LED 7x4,5W 230V  
 2660lm - 3000°K upon request 2700°/4000°K  
 CE IP20  
 Net weight 4500gr - Gross weight 5200gr  
 Volume m<sup>3</sup> 0,046  
 Dimmable PHASE-CUT DIMMING

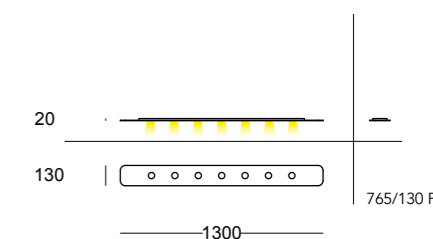
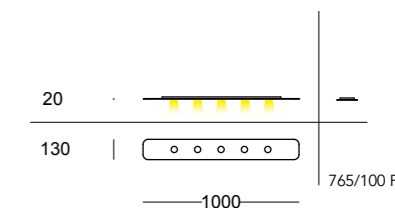



# Plateau

design by C. Cattaneo

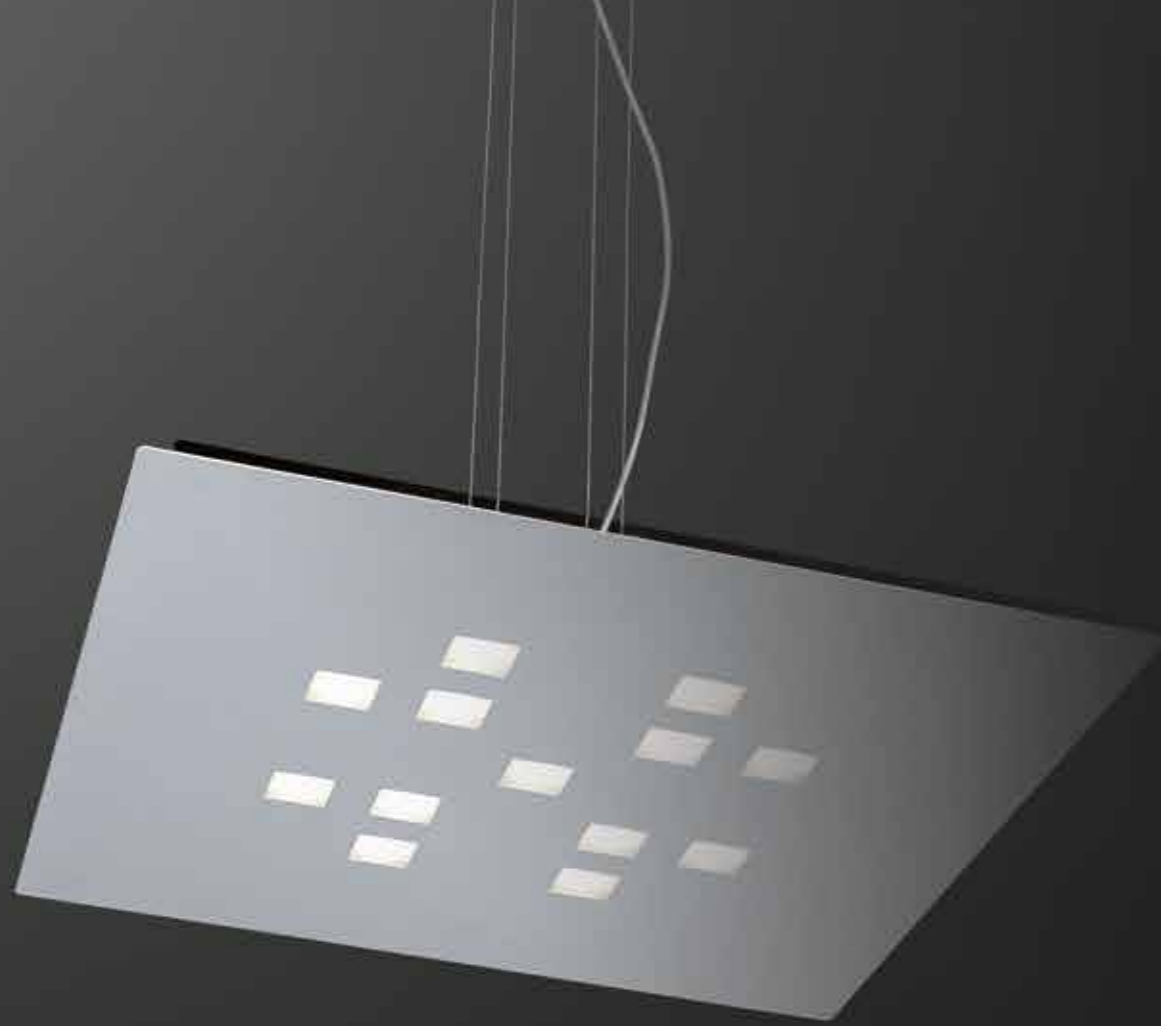

Lampada da plafone e da sospensione formata da un pannello in metallo sottilissimo con fori quadrati per una illuminazione a LED.

Ceiling and suspension lamp consisting of a thin metal sheet with square holes that accommodate LED lights.

Decken- und Haengelampe mit einer sehr feinen metallischen Verkleidung mit eingearbeiteten quadratischen Foren fuer LED Beleuchtung.



White

Sandy

Grey



**773/52 S**

LED 9x4,5W 230V  
 3420lm 3000°K upon request 2700°/4000°K  
 CE IP20  
 Net weight 6950gr - Gross weight 8000gr  
 Volume m<sup>3</sup> 0,047

 PHASE-CUT DIMMING

**773/60 S**

LED 13x4,5W 230V  
 4940lm 3000°K upon request 2700°/4000°K  
 CE IP20  
 Net weight 7980gr - Gross weight 9100gr  
 Volume m<sup>3</sup> 0,077

 PHASE-CUT DIMMING

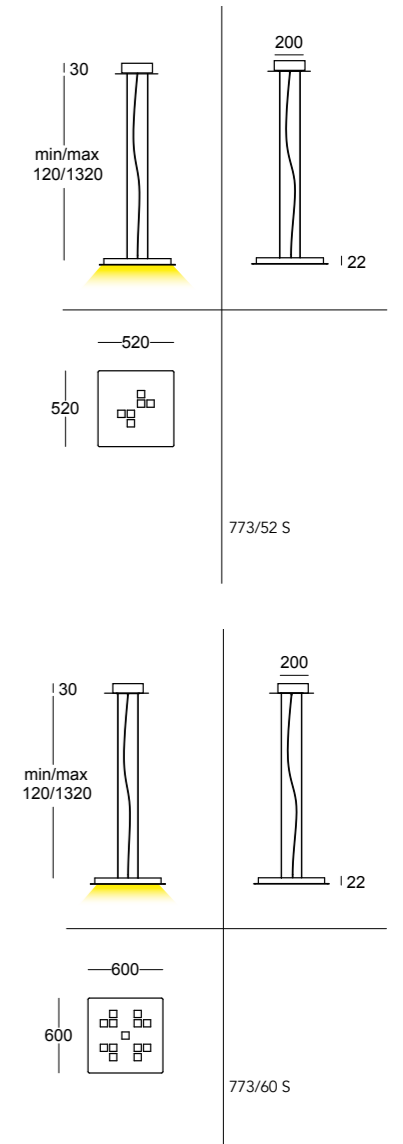



White

Sandy

Grey

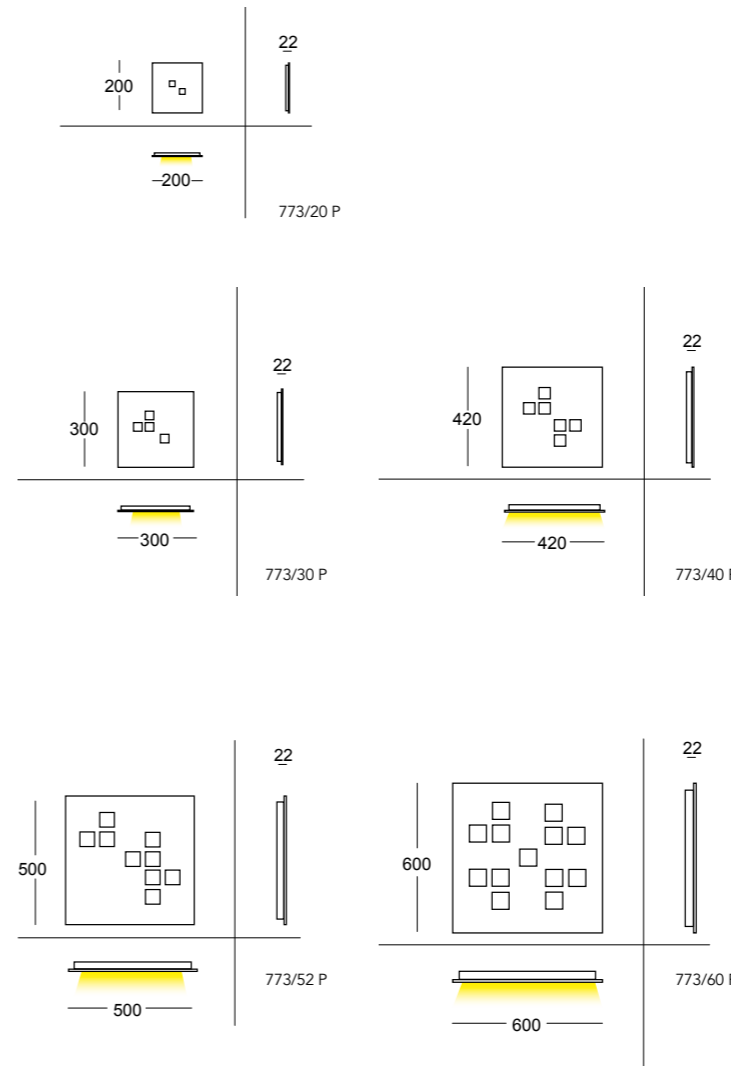

**773/20 P**

LED 2x4,5W 230V  
 760lm 3000°K upon request 2700°/4000°K  
 CE IP20  
 Net weight 950gr - Gross weight 1500gr  
 Volume m<sup>3</sup> 0,014  
 Dimmable PHASE-CUT DIMMING

**773/30 P**

LED 4x4,5W 230V  
 1520lm 3000°K upon request 2700°/4000°K  
 CE IP20  
 Net weight 1650gr - Gross weight 2800gr  
 Volume m<sup>3</sup> 0,020  
 Dimmable PHASE-CUT DIMMING

**773/40 P**

LED 6x4,5W 230V  
 2280lm 3000°K upon request 2700°/4000°K  
 CE IP20  
 Net weight 3800gr - Gross weight 5200gr  
 Volume m<sup>3</sup> 0,029  
 Dimmable PHASE-CUT DIMMING

**773/52 P**

LED 9x4,5W 230V  
 3420lm 3000°K upon request 2700°/4000°K  
 CE IP20  
 Net weight 6200gr - Gross weight 7700gr  
 Volume m<sup>3</sup> 0,077  
 Dimmable PHASE-CUT DIMMING

**773/60 P**

LED 13x4,5W 230V  
 4940lm 3000°K upon request 2700°/4000°K  
 CE IP20  
 Net weight 7600gr - Gross weight 10100gr  
 Volume m<sup>3</sup> 0,077  
 Dimmable PHASE-CUT DIMMING

# Adjustable

design by E. Giudici



Una pallina da golf è il segreto della funzionalità di Adjustable. Lampada da parete con una struttura in alluminio satinato con inserti cromati, grazie ai suoi movimenti permette una flessibile installazione nell'ambiente.

A golf ball is the secret that makes Adjustable so functional. This wall lamp features a matt aluminium body with chromed details. Thanks to its being adjustable, it can be installed in a very versatile way in every environments.

In einem Golfball steckt das Geheimnis der Funktionalitaet von Adjustable. Eine Wandleuchte mit einer Alluminium satinierten und mit Chromaten eingelegten Struktur, welche auf Grund ihrer Beweglichkeit eine flexible Installation im Ambiente anbietet.





**137/150 A**  
 220-240V - E27 LED  
 CE IP20  
 Net weight 1556gr - Gross weight 3306gr  
 Volume m<sup>3</sup> 0,090  
 2 boxes

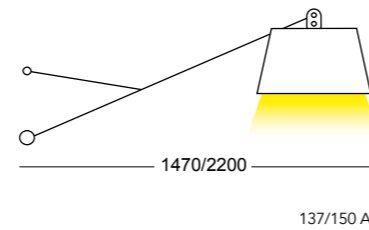

Adjustable | Ceiling

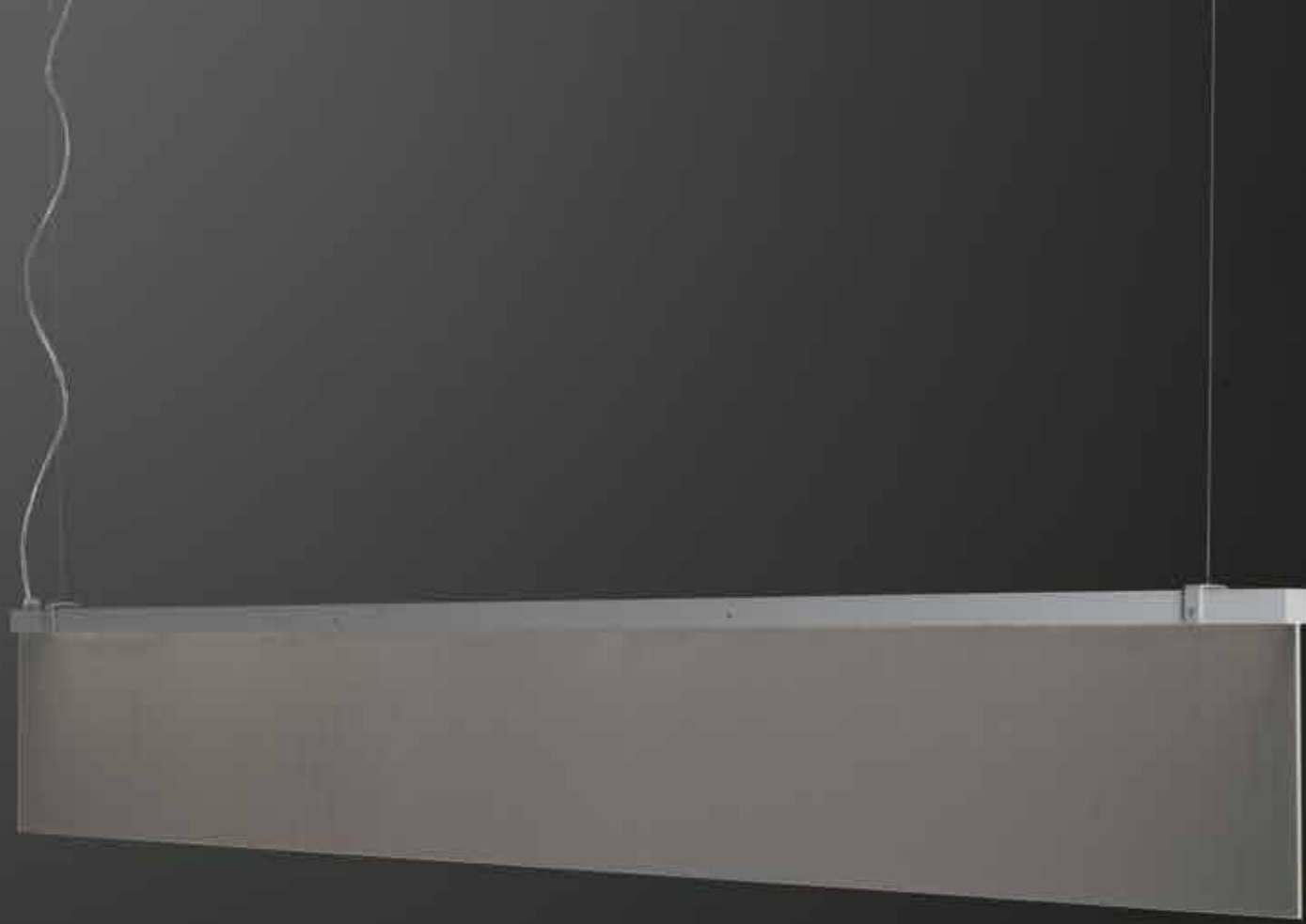

# Plane

design by C. Cattaneo

Elegante ed originale, Plane è la lampada adatta ad ogni tipo di ambiente. Grazie ai suoi giochi di trasparenze, illuminerà le tue stanze creando atmosfere magiche.

Elegant and unique, Plane is the perfect light for any environment. Thanks to its play on transparencies, it will light your rooms creating magic atmospheres.

Stylish Und originell, die Plane ist die Lampe für jede Art von Umgebung geeignet. Mit seinen Transparenz, beleuchten Ihr Zimmer, und ändert es zur eine magische Atmosphäre.

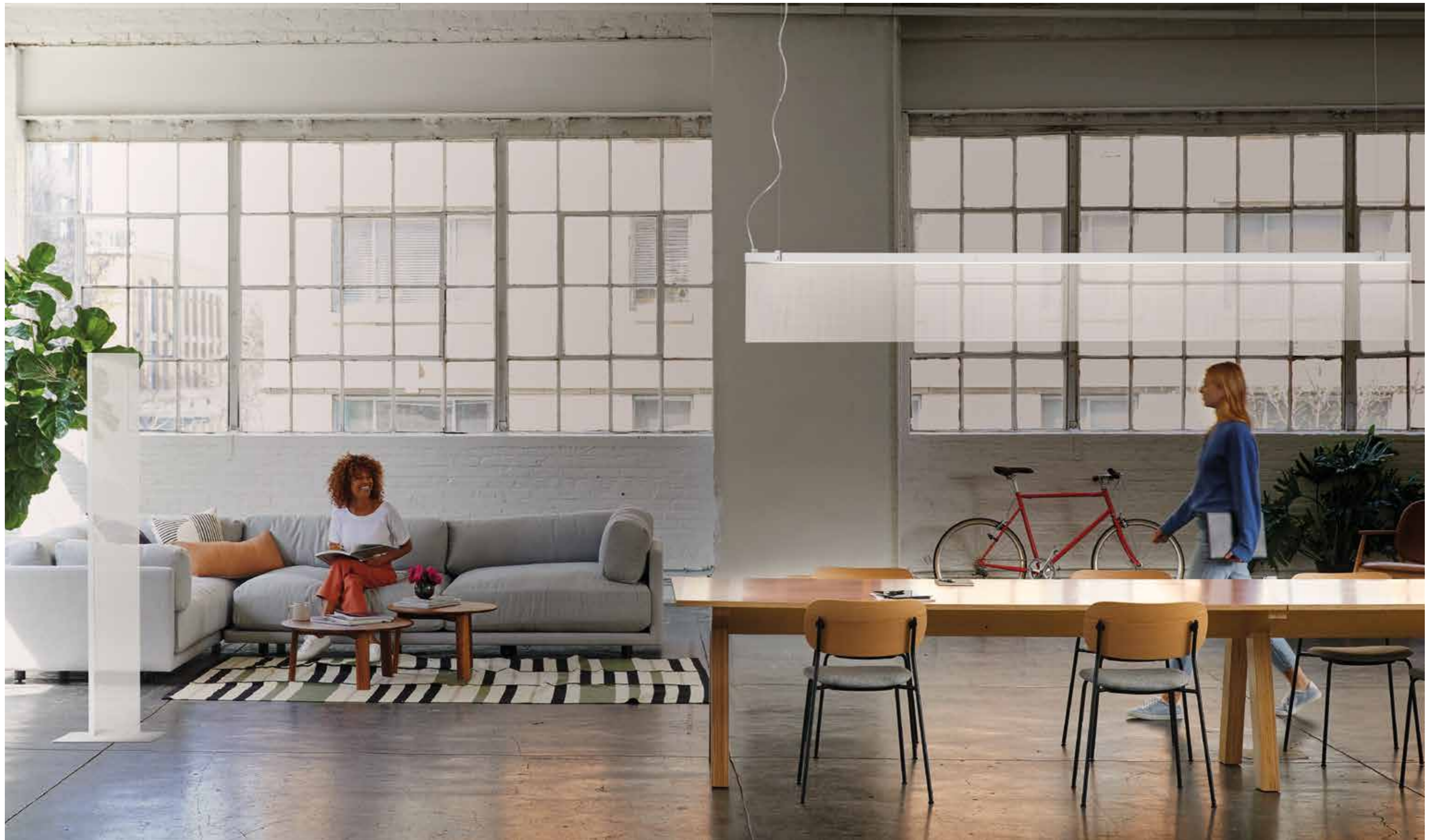





Transparent



**782/170 S**

LED 6x10W 220-240V

7200lm - 3000°K upon request 2700°/4000°K

CE IP20

Net weight 3500gr - Gross weight 7180gr

Volume m<sup>3</sup> 0,22

 PHASE-CUT DIMMING

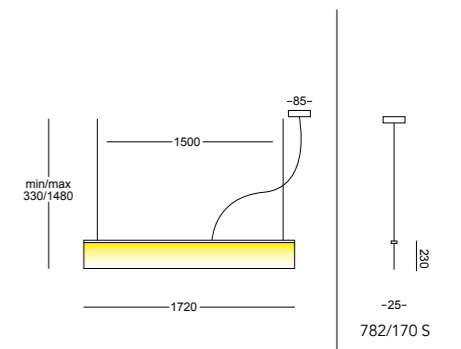



**782/170 T**

LED 6x10W 220-240V

7200lm - 3000°K upon request 2700°/4000°K

CE IP20

Net weight 8700gr - Gross weight 14180gr

Volume m<sup>3</sup> 0,24

2 boxes

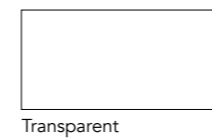
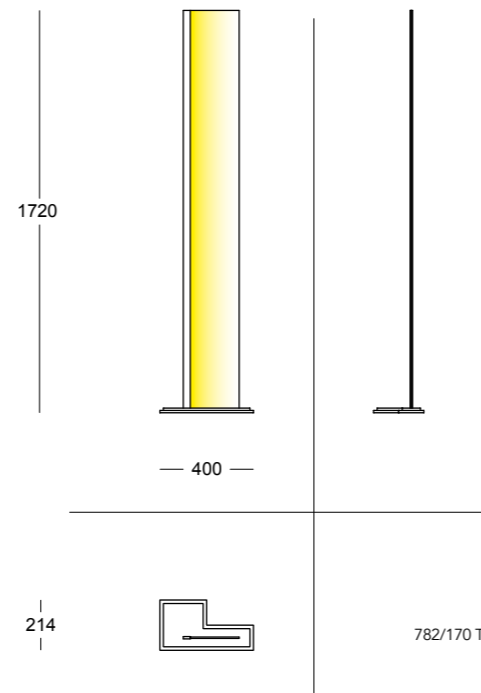

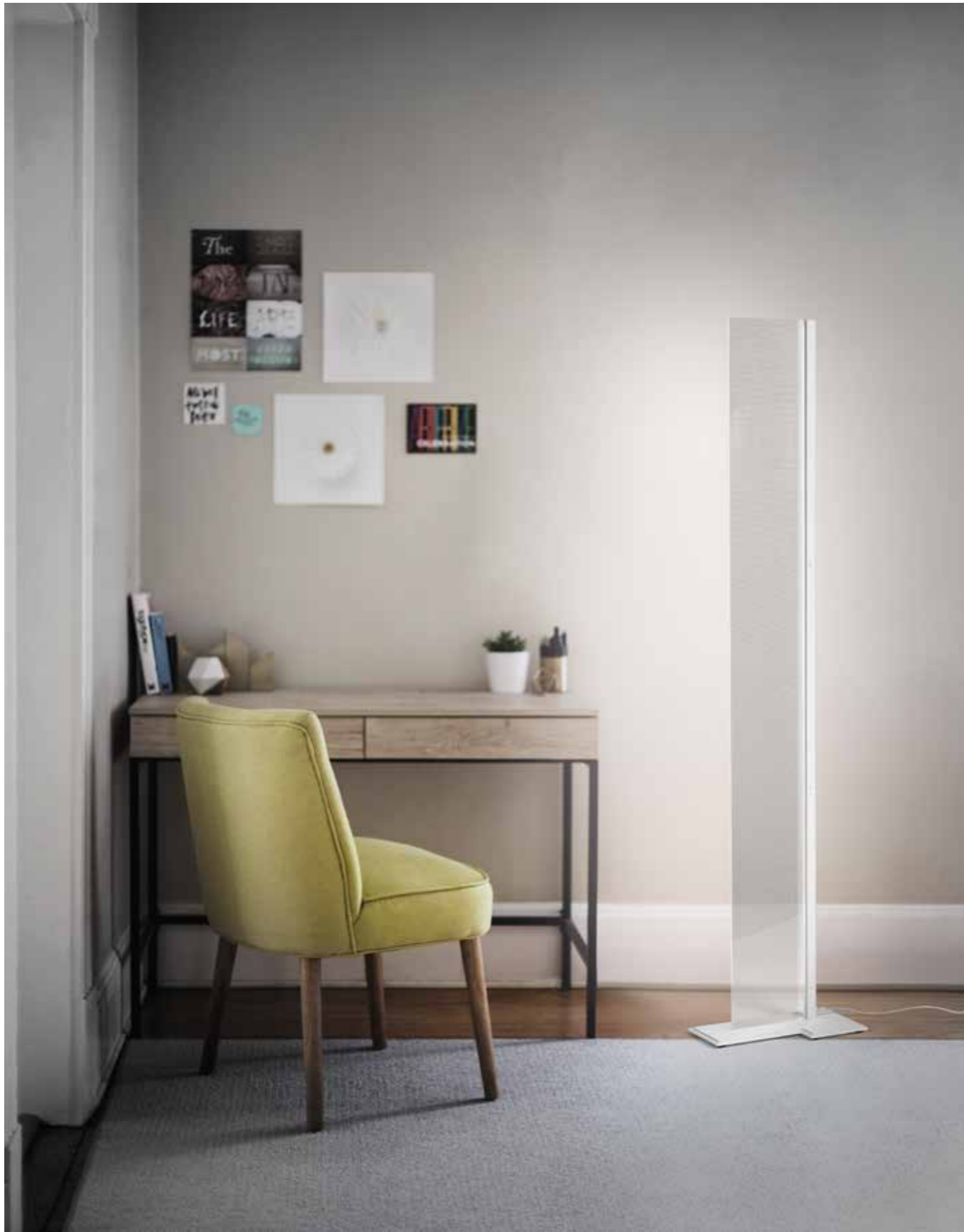



# Spin

design by C. Cattaneo

Da sola, o con le sue sorelle, per stupire con giochi di luce di cui si arricchisce il polycarbonato trasparente una volta illuminato.

Spin è una lampada a forma cilindrica che ti farà girare la testa, la sua voglia di stupire illuminerà anche le tue giornate più buie.

Alone or with its sisters, once the clear polycarbonate is illuminated, Spin will embellish with impressive play of light. Cylindrical in shape, Spin is a light that will make your head spin. Its desire to impress will make even your darker days brighter.

Allein oder mit ihren Schwestern, mit Licht zu überraschen, die Transparente Polycarbonat wird verstärkt, wenn beleuchtet ist. Der Spin ist eine zylindrische Lampe, die Ihren Kopf verdrehen wird, seinen Wunsch ist es dich stets zu überraschen, auch in Ihre dunkelsten Tage.

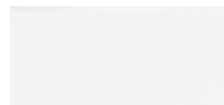

White



**858/13 S**

LED 1x7W-24V Dc

1000lm 3000°K upon request 2700°/4000°K

CE  IP20

Net weight 1137gr - Gross weight 1657gr

Volume m<sup>3</sup> 0,033

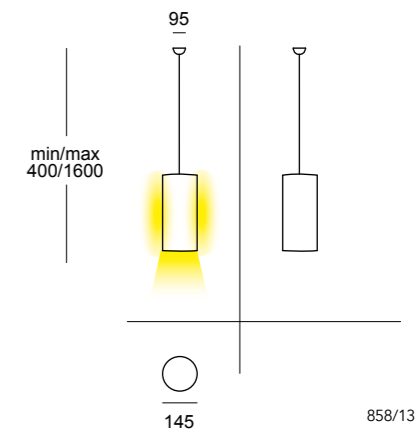



**858/13 T**  
 LED 5x7W-24V Dc  
 5000 Lm 3000°K upon request 2700°/4000°K  
 CE  $\oplus$  IP20  
 Net weight 16900gr - Gross weight 21820gr  
 Volume m<sup>3</sup> 0,32  
 6 boxes  
 Remote control included

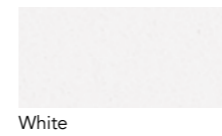
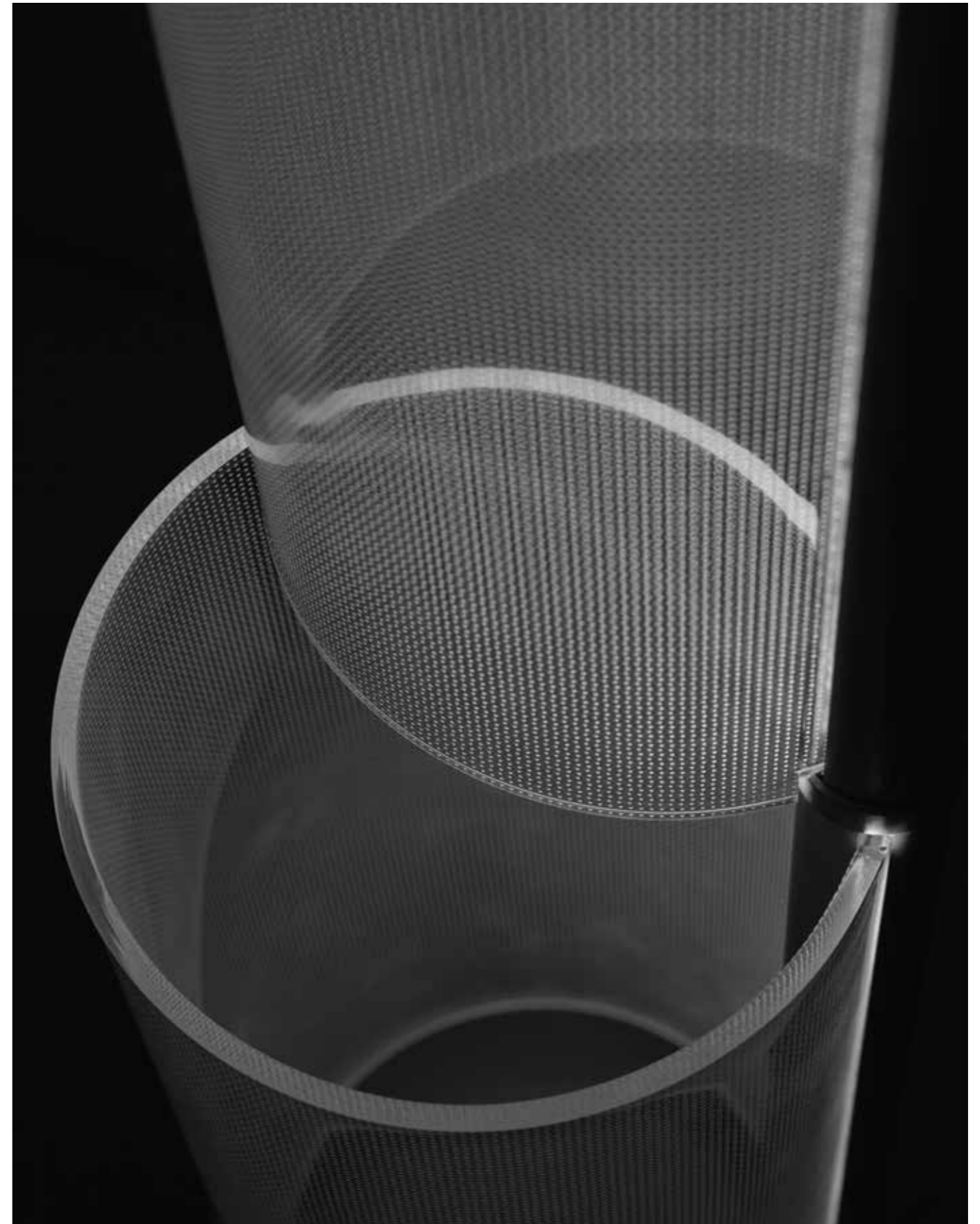
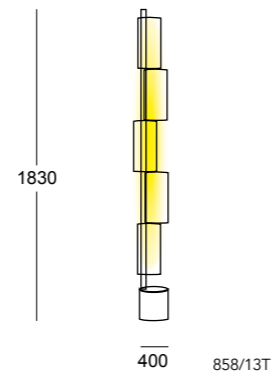

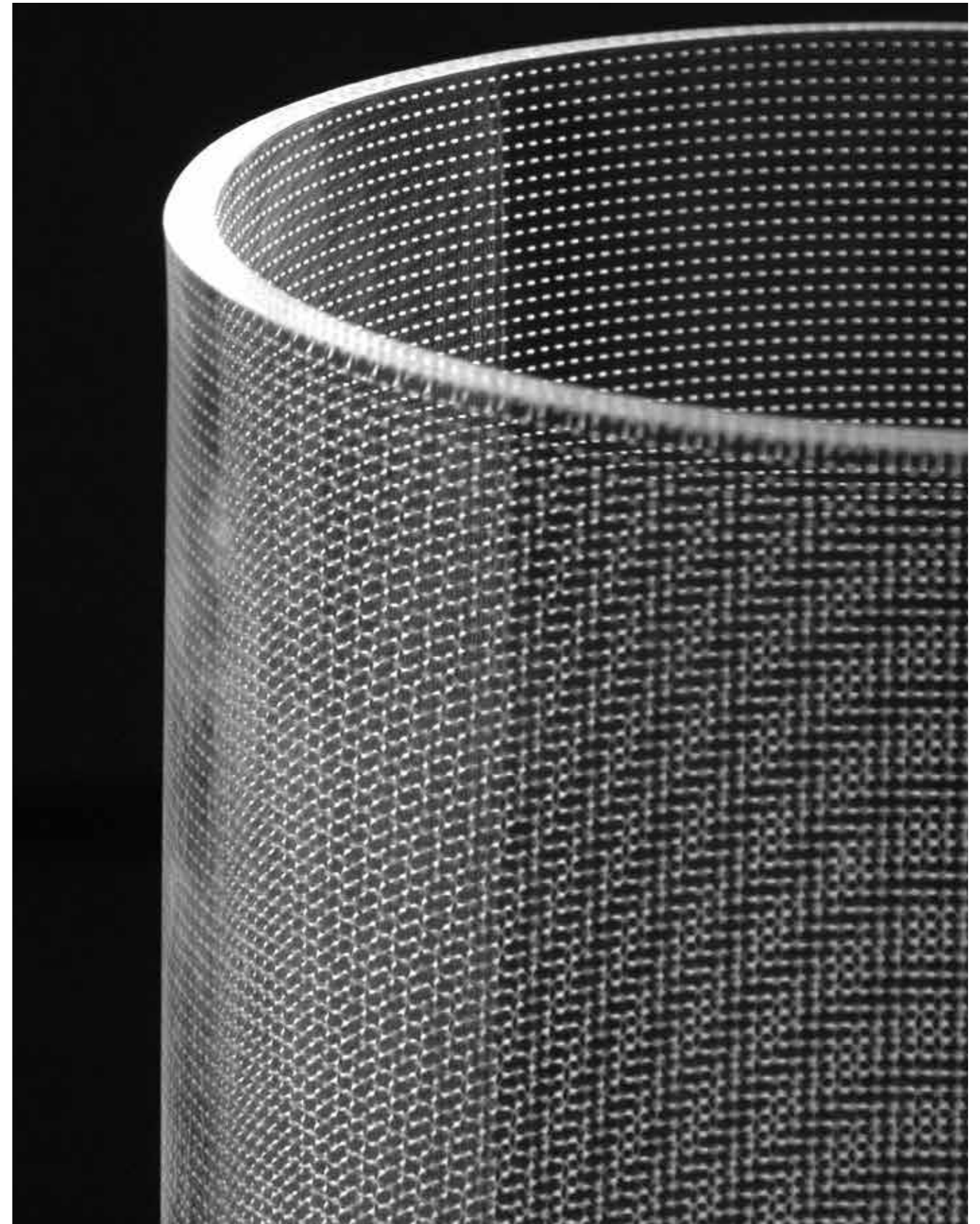

# Bambù

design by C. Cattaneo

Originale lampada da terra e da sospensione ispirata alla pianta del bambù. E' una lampada di vetro bianco latte satinato con luce a LED.

La sospensione presenta due varianti di forme per diverse esigenze d'arredo.

Original floor and suspended lamp inspired by bamboo plants. Matt milky-white fixture with LED light. Available in two different shapes for multiple interior designs.

Originelle Stehleuchte und Hängeleuchte, inspiriert von der Pflanze Bambus. Es ist eine milchig-weiße satinierte Glaslampe mit LED-Licht. Die Hängeleuchte hat zwei verschiedene Formen für unterschiedliche Einrichtungsbedürfnisse.



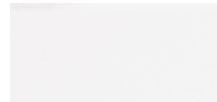

White

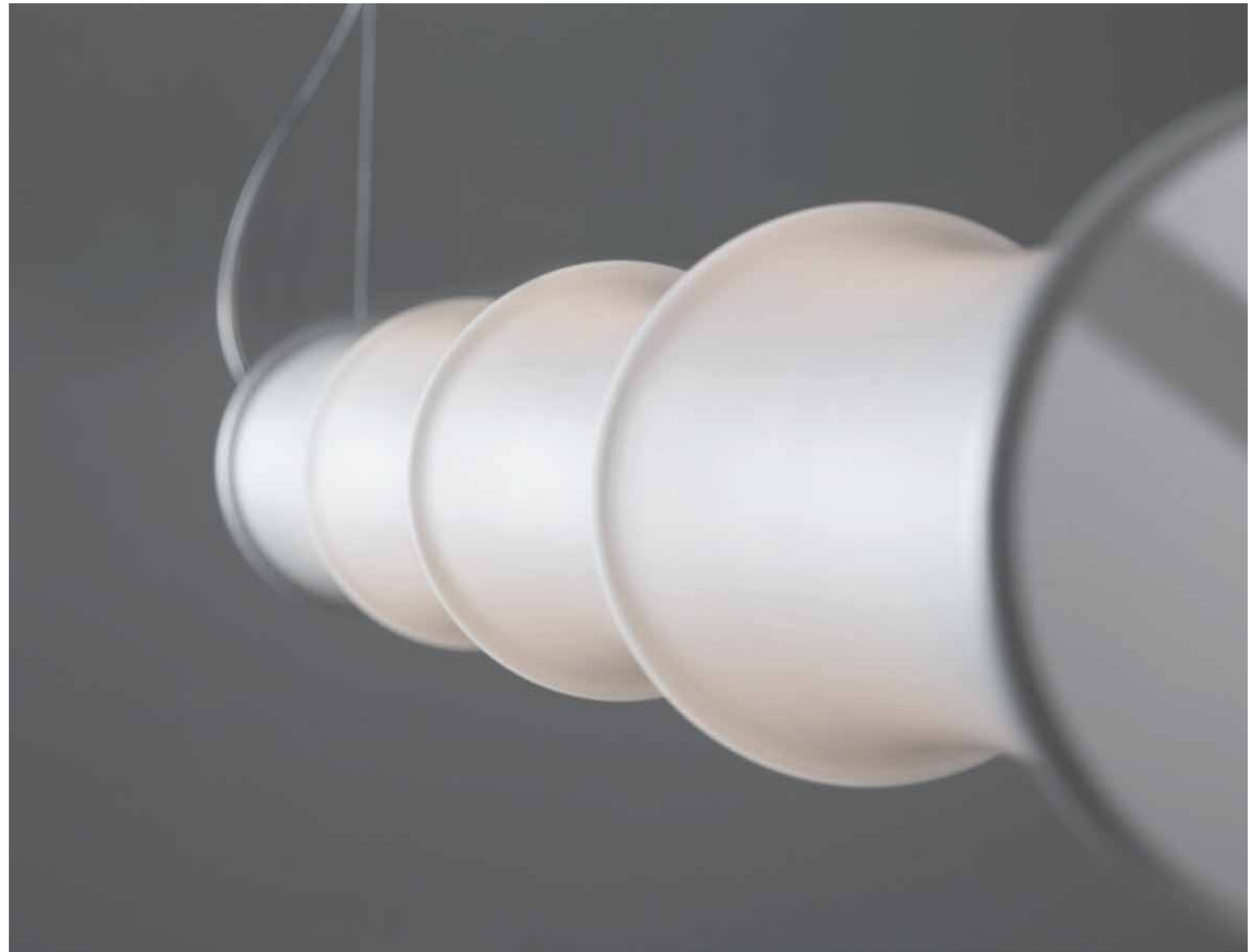
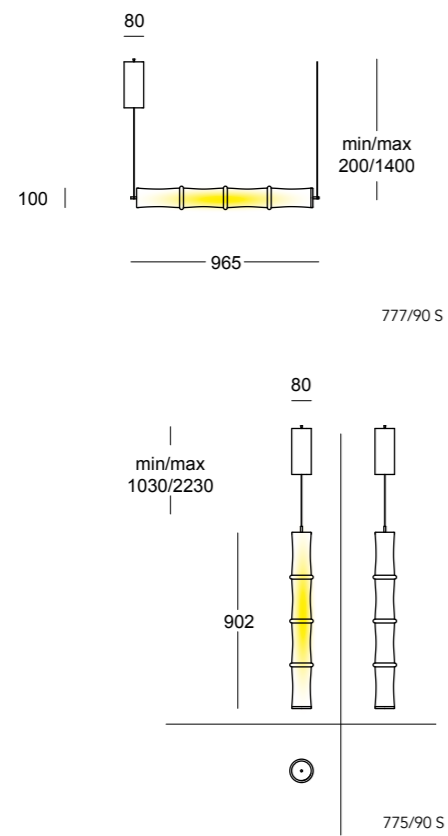

**775/90 S**

LED 35W 24V 220-240V

2700lm - 3200°K

CE IP20

Net weight 3600gr - Gross weight 5000gr

Volume m<sup>3</sup> 0,045

TOUCH DIMMING

**777/90 S**

LED 35W 24V 220-240V

2700lm - 3200°K

CE IP20

Net weight 3600gr - Gross weight 5000gr

Volume m<sup>3</sup> 0,045

TOUCH DIMMING



White

Brown

Grey



**775/180 T**

LED 70W 24V 220-240V  
5400lm - 3200°K

CE IP20

Net weight 11630gr - Gross weight 17170gr

Volume m<sup>3</sup> 0,67 - 3 boxes

TOUCH DIMMING

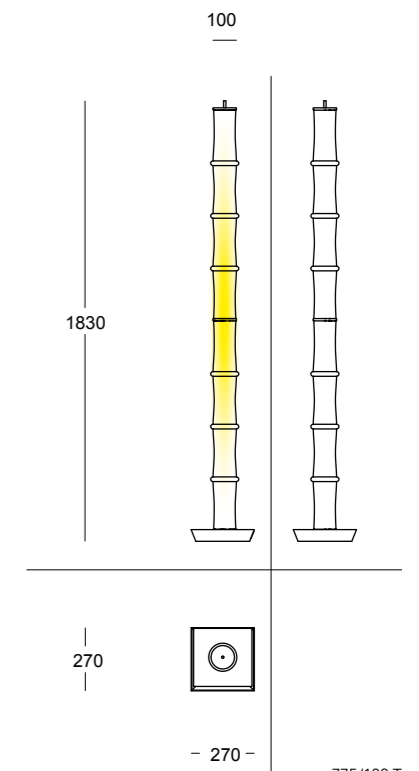

Bambù | Floor

775/180 T



# Nuvola

design by C. Cattaneo

Un inconsueto modello di lampada da parete, da sospensione, da soffitto e da tavolo per caratterizzare in modo diverso l'arredo d'interni. Come tutti i modelli anche quello da tavolo sembra un soffice oggetto da accarezzare.

An unconventional wall, suspended, ceiling or table lamp that gives a unique touch to the interior. In the same way as the other versions, also the table lamp evokes a feeling of softness.

Ein ungewöhnliches Modell als Wandleuchte, Hänge-, Decken- oder Tischlampe kann die unterschiedlichen Arten der Inneneinrichtungen charakterisieren. Wie alle Modelle auch die Tischlampe bietet den Eindruck eines weichen Objektes zum Streicheln.

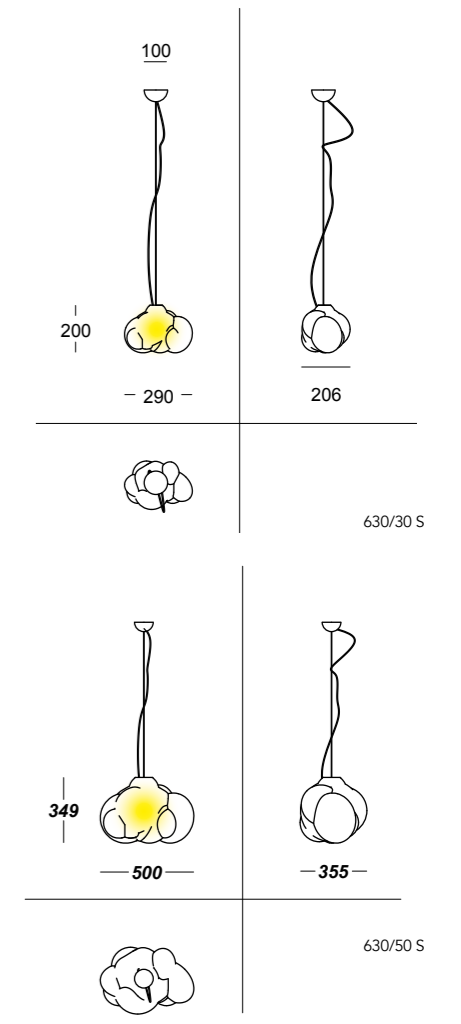

**630/30 S**

220-240V - E14 LED

CE IP20

Net weight 1450gr - Gross weight 2050gr

Volume m<sup>3</sup> 0,020

**630/50 S**

220-240V - E27 LED

CE IP20

Net weight 3900gr - Gross weight 5500gr

Volume m<sup>3</sup> 0,064

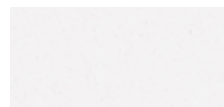
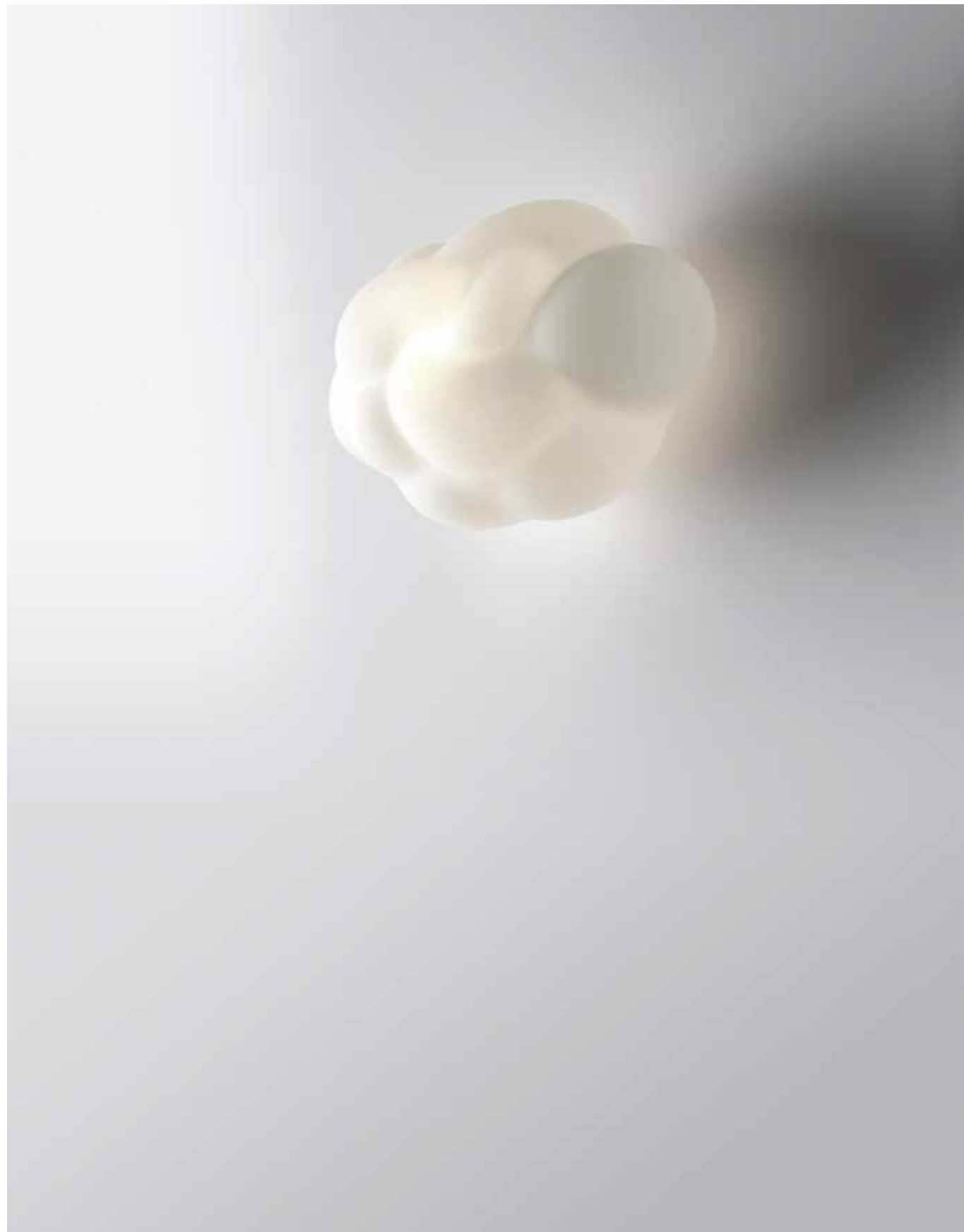

White



**630/30 PA**

220-240V - E14 LED

CE IP20

Net weight 1450gr - Gross weight 2050gr

Volume m<sup>3</sup> 0,020

**630/50 PA**

220-240V - E27 LED

CE IP20

Net weight 3900gr - Gross weight 5500gr

Volume m<sup>3</sup> 0,064

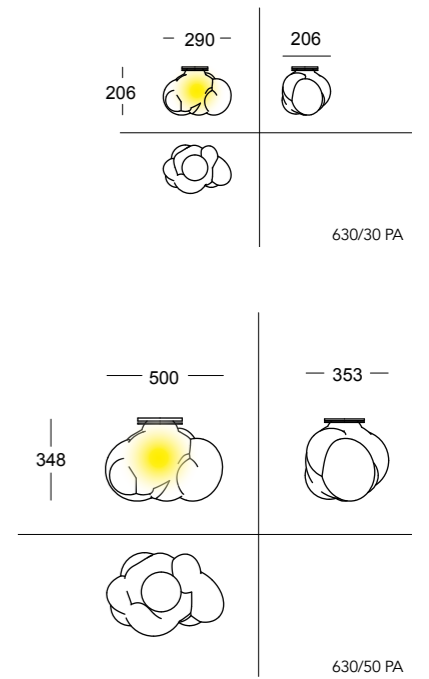



**630/30 PA**

220-240V - E14 LED

CE IP20

Net weight 1450gr - Gross weight 2050gr

Volume m<sup>3</sup> 0,020

**630/50 PA**

220-240V - E27 LED

CE IP20

Net weight 3900gr - Gross weight 5500gr

Volume m<sup>3</sup> 0,064

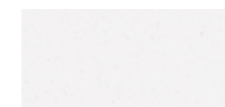
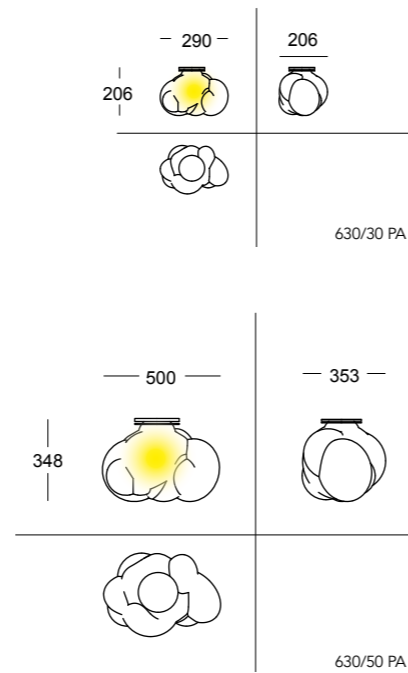

White

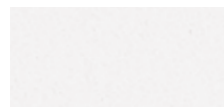

White



**630/30 L**

220-240V - E14 LED

CE IP20

Net weight 1450gr - Gross weight 2050gr

Volume m<sup>3</sup> 0,020

**630/50 L**

220-240V - E27 LED

CE IP20

Net weight 3900gr - Gross weight 5500gr

Volume m<sup>3</sup> 0,064

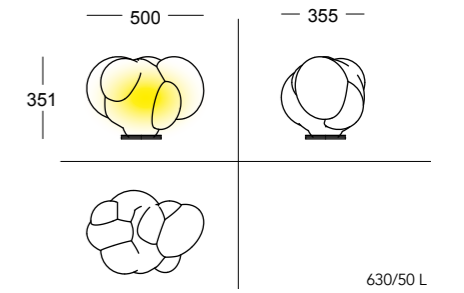
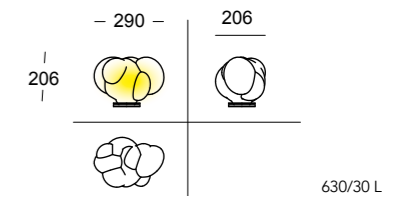



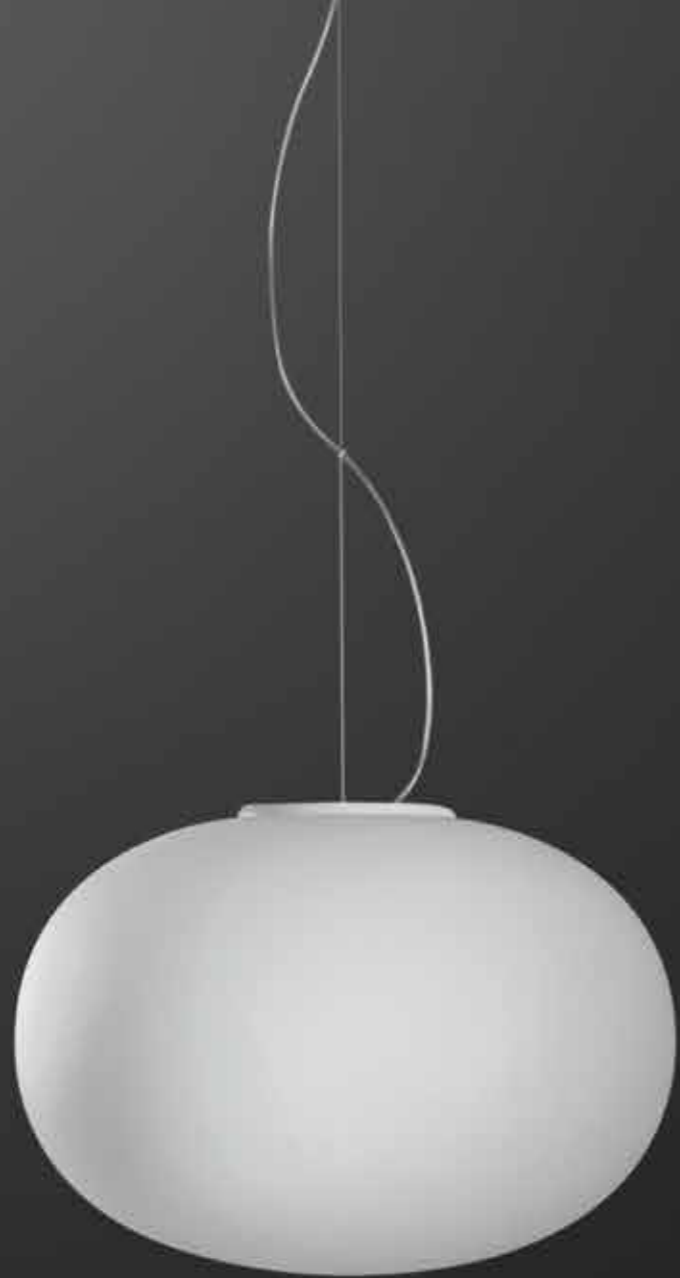

# Mercury

design by C. Cattaneo

Il vetro soffiato bianco latte è il punto dal quale scaturisce la luce che pervade tutto l'ambiente. La struttura è in metallo disponibile nel colore bianco.

A light pervading all the interior shines from milky-white blown glass. The structure is in white painted metal.

Das milchig weisse, mundgeblasene Glas ist der Faktor damit das gesamte Ambiente von Licht getraenkt wird. Die Struktur ist aus Metall , verfuegbar in den Farben Weiss.



**1041/40 S**

220-240V - E27 LED

CE IP20

Net weight 2800gr - Gross weight 3900gr

Volume m<sup>3</sup> 0,053

**1041/50 S**

220-240V - E27 LED

CE IP20

Net weight 4400gr - Gross weight 6500gr

Volume m<sup>3</sup> 0,098

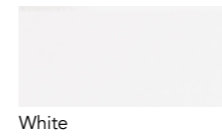
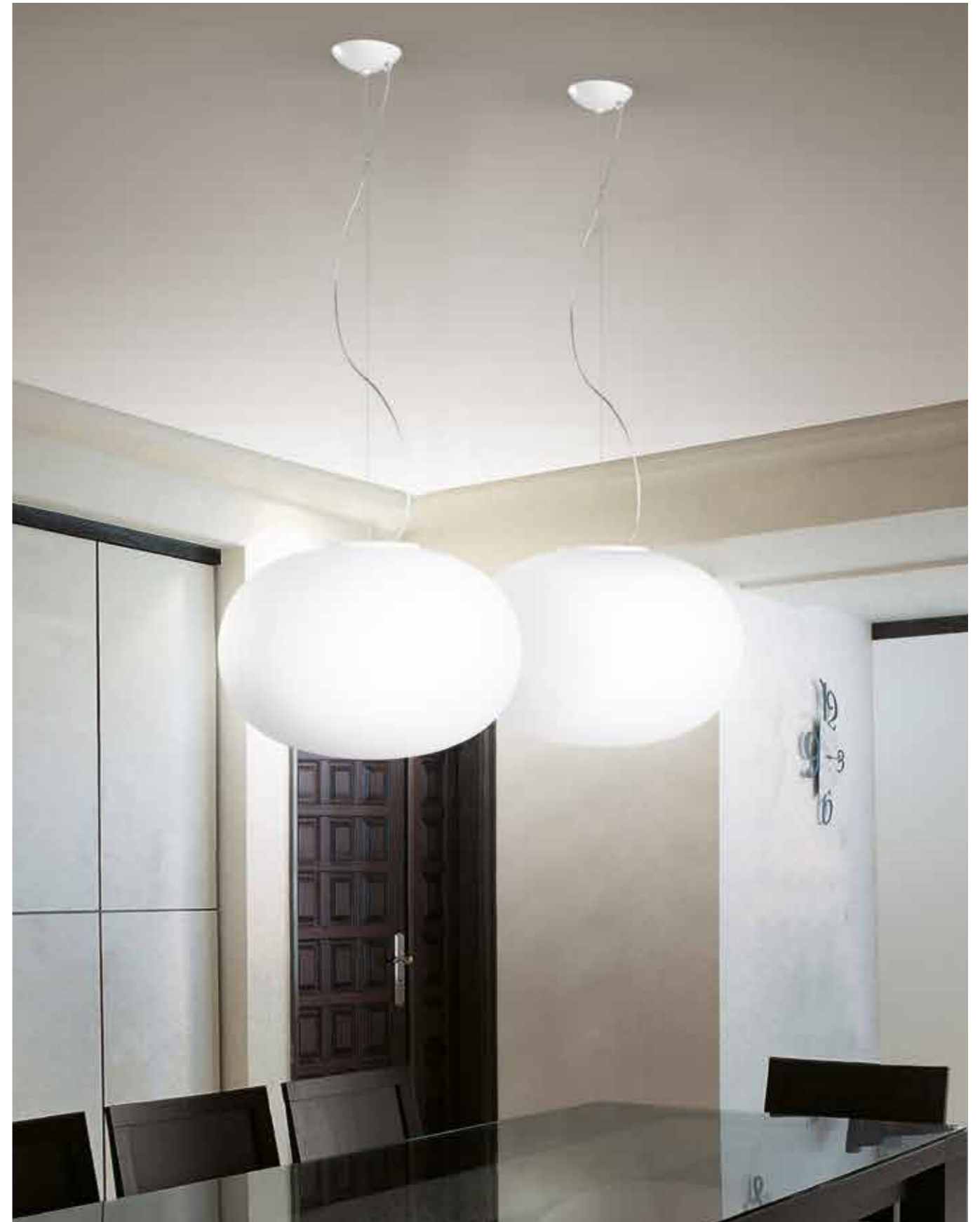
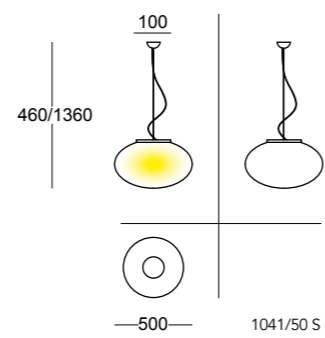
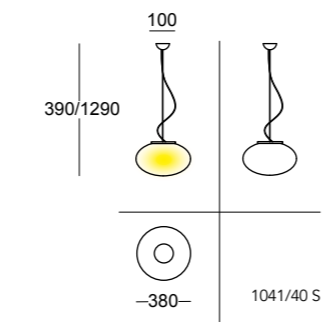



**1041/16 P**

220-240V - G9 LED

CE IP20

Net weight 700gr - Gross weight 1020gr

Volume m<sup>3</sup> 0,0092

**1041/40 P**

220-240V - E27 LED

CE IP20

Net weight 2800gr - Gross weight 3900gr

Volume m<sup>3</sup> 0,053

**1041/50 P**

220-240V - E27 LED

CE IP20

Net weight 4400gr - Gross weight 6500gr

Volume m<sup>3</sup> 0,098

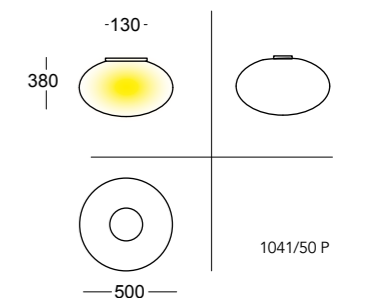
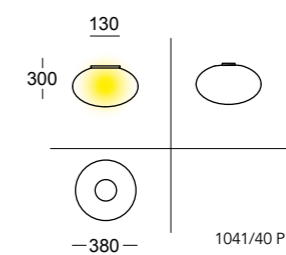
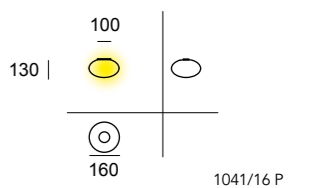

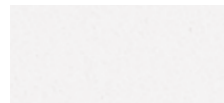

White



**1041/40 T**

220-240V - E27 LED

CE IP20

Net weight 6890gr - Gross weight 9900gr

Volume m<sup>3</sup> 0,11

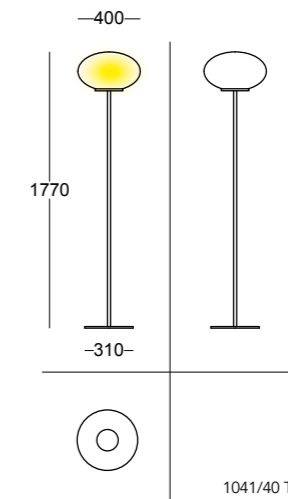



**1041/16 L**

220-240V - G9 LED

CE IP20

Net weight 700gr - Gross weight 1020gr

Volume m<sup>3</sup> 0,0092

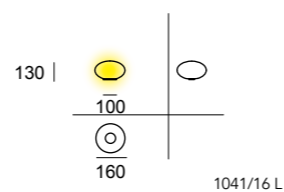

**1041/40 L**

220-240V - E27 LED

CE IP20

Net weight 2800gr - Gross weight 3900gr

Volume m<sup>3</sup> 0,053

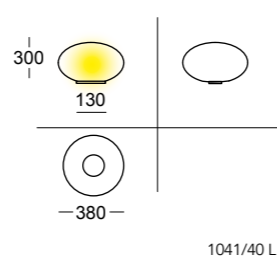

**1041/50 L**

220-240V - E27 LED

CE IP20

Net weight 4400gr - Gross weight 6500gr

Volume m<sup>3</sup> 0,098

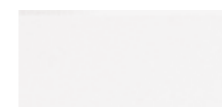
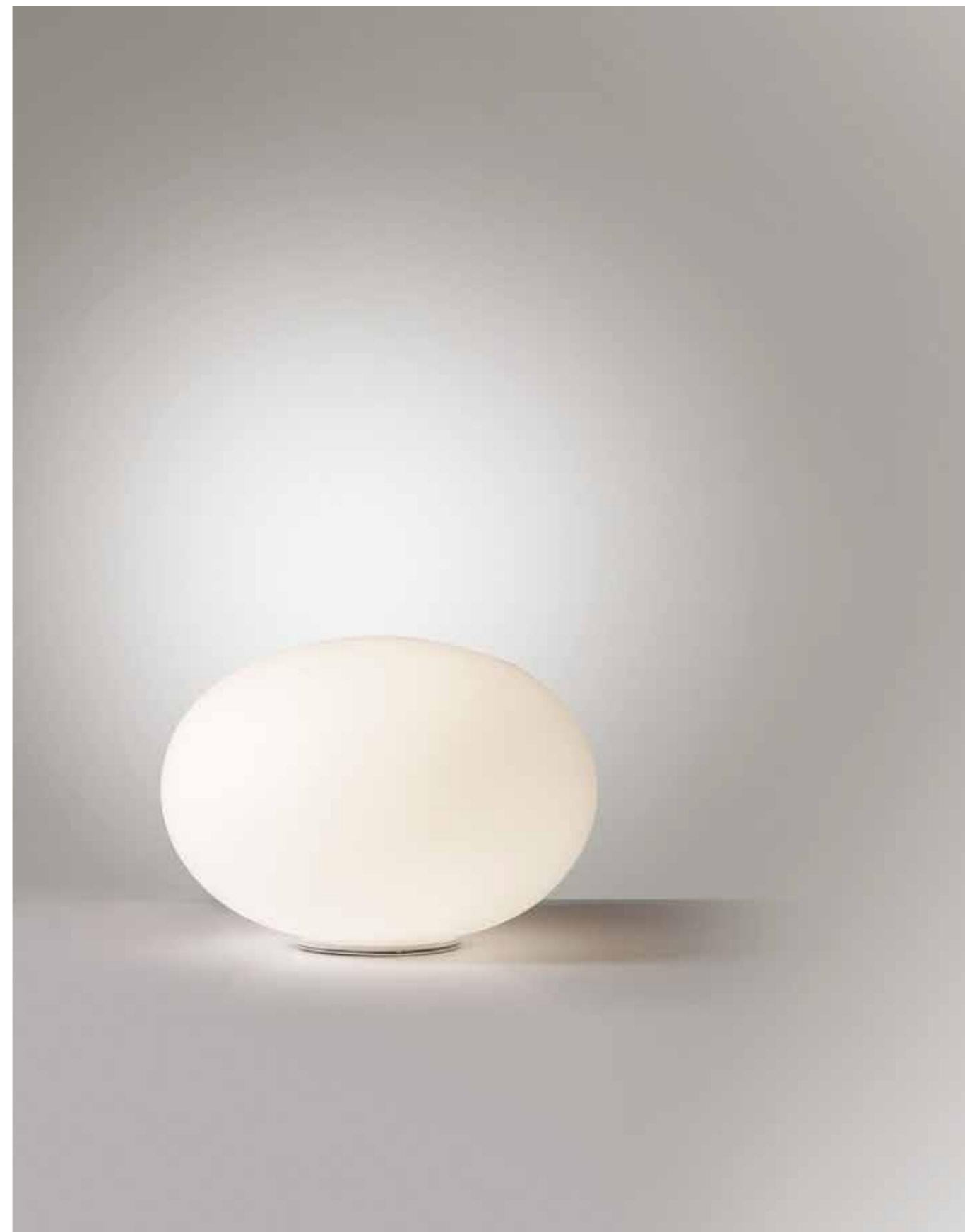
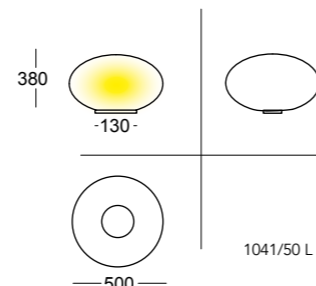

White

# alphabetical index

<b>Abbraccio</b>	770/70 A	250
<b>Abbraccio</b>	770/36 A	250
<b>Abbraccio</b>	770/21 A	250
<b>Adjustable</b>	137/150 A	280
<b>Ball</b>	865/18 S	63
<b>Bambù</b>	777/90 S	304
<b>Bambù</b>	775/90 S	304
<b>Bambù</b>	775/180 T	307
<b>Basalt</b>	897/60 P	161
<b>Biquadro</b>	879/60 S	213
<b>Biscotto</b>	765/60 PA	269
<b>Biscotto</b>	765/130 S	267
<b>Biscotto</b>	765/130 PA	269
<b>Biscotto</b>	765/100 S	267
<b>Biscotto</b>	765/100 PA	269
<b>Bolle</b>	755/60 S	255
<b>Bolle</b>	755/60 PA	257
<b>Bolle</b>	755/30 S	255
<b>Bolle</b>	755/30 PA	257
<b>Cone</b>	867/12 S	67
<b>Cubick</b>	899/9 A	225
<b>Cubick</b>	899/7 A	225
<b>Cubick</b>	899/5 A	225
<b>Cubick</b>	768/9 S	231
<b>Cubick</b>	768/9 P	228
<b>Cubick</b>	768/7 S	231
<b>Cubick</b>	768/7 P	228
<b>Cubick</b>	768/5 S	231
<b>Cubick</b>	768/5 P	228
<b>Cubick</b>	767/9 L	232
<b>Cubick</b>	767/9 A	227
<b>Cubick</b>	767/7 L	232
<b>Cubick</b>	767/7 A	227
<b>Cubick</b>	767/5 L	232
<b>Cubick</b>	767/5 A	227
<b>Dinamica</b>	896/80 S	126
<b>Dinamica</b>	896/60 S	126
<b>Dinamica</b>	896/120 S	126
<b>Drop</b>	786/13 S	12
<b>E.R.</b>	850/1 S	78
<b>Fuorisquadra</b>	764/64 S	261
<b>Fuorisquadra</b>	764/64 PA	263
<b>Fuorisquadra</b>	764/50 S	261
<b>Fuorisquadra</b>	764/50 PA	263
<b>Fuorisquadra</b>	764/35 PA	263
<b>Fuorisquadra</b>	764/25 PA	263
<b>Fuorisquadra</b>	764/100 S	261
<b>Fuorisquadra</b>	764/100 PA	263
<b>Heron</b>	810/95 PA	113

<b>Heron</b>	810/95 S	120
<b>Heron</b>	810/95 M	121
<b>Heron</b>	810/95 AS	107
<b>Heron</b>	810/95 AD	107
<b>Heron</b>	810/75 PA	113
<b>Heron</b>	810/75 AS	107
<b>Heron</b>	810/75 AD	107
<b>Heron</b>	810/15 R3	121
<b>Heron</b>	810/15 R2	121
<b>Heron</b>	810/120 S	120
<b>Heron</b>	810/120 PA	113
<b>Heron</b>	810/120 M	121
<b>Heron</b>	810/120 AS	107
<b>Heron</b>	810/120 AD	107
<b>Iron</b>	855/1 P	89
<b>Kami</b>	891/90 S	146
<b>Kami</b>	891/30 A	150
<b>Kami</b>	891/120 S	146
<b>Katana</b>	870/200 T	179
<b>Katana</b>	870/130 S2	175
<b>Katana</b>	870/130 S	173
<b>Katana</b>	870/100 S2	175
<b>Katana</b>	870/100 S	173
<b>Mercury</b>	1041/50 S	320
<b>Mercury</b>	1041/50 P	323
<b>Mercury</b>	1041/50 L	326
<b>Mercury</b>	1041/40 T	325
<b>Mercury</b>	1041/40 S	320
<b>Mercury</b>	1041/40 P	323
<b>Mercury</b>	1041/40 L	326
<b>Mercury</b>	1041/16 P	323
<b>Mercury</b>	1041/16 L	326
<b>Mini Mercury</b>	784/16 S	36
<b>Mini Soft</b>	785/16 S	20
<b>Nassa</b>	864/80 S	185
<b>Nassa</b>	864/60 S	185
<b>Ninfea</b>	895/90 P	169
<b>Ninfea</b>	895/70 P	169
<b>Nuts</b>	780/14 S	56
<b>Nuvola</b>	630/50 S	311
<b>Nuvola</b>	630/50 PA	313
<b>Nuvola</b>	630/50 PA	314
<b>Nuvola</b>	630/50 L	317
<b>Nuvola</b>	630/30 S	311
<b>Nuvola</b>	630/30 PA	313
<b>Nuvola</b>	630/30 PA	314
<b>Nuvola</b>	630/30 L	317
<b>Olimpia</b>	862/16 PA	193
<b>Plane</b>	782/170 T	288

<b>Plane</b>	782/170 S	287
<b>Plateau</b>	773/60 S	273
<b>Plateau</b>	773/60 P	275
<b>Plateau</b>	773/52 S	273
<b>Plateau</b>	773/52 P	275
<b>Plateau</b>	773/40 P	275
<b>Plateau</b>	773/30 P	275
<b>Plateau</b>	773/20 P	275
<b>Quadretto</b>	761/10 A	217
<b>Spin</b>	858/13 T	296
<b>Spin</b>	858/13 S	295
<b>Square</b>	860/20 A	207
<b>Stone</b>	853/1 P	85
<b>Stretch</b>	776/1 S	43
<b>Thesis</b>	894/70 PA	139
<b>Thesis</b>	894/60 PA	139
<b>Thesis</b>	894/30 C	141
<b>Time</b>	783/11 S	30
<b>Tratto</b>	774/90A IP	243
<b>Tratto</b>	774/90 A	243
<b>Tratto</b>	774/60 A IP	243
<b>Tratto</b>	774/60 A	243
<b>Tratto</b>	754/90A IP	240
<b>Tratto</b>	754/90 A	240
<b>Tratto</b>	754/90 S	237
<b>Tratto</b>	754/90 PA IP	245
<b>Tratto</b>	754/90 PA	245
<b>Tratto</b>	754/60A IP	240
<b>Tratto</b>	754/60 A	240
<b>Tratto</b>	754/60 PA IP	245
<b>Tratto</b>	754/60 PA	245
<b>Tratto</b>	754/30A IP	242
<b>Tratto</b>	754/30 A	242
<b>Tratto</b>	754/30 PA IP	245
<b>Tratto</b>	754/30 PA	245
<b>Volvit</b>	892/18 A	157
<b>Volvit</b>	892/15 A	157
<b>Waterfall</b>	M 151	103
<b>Waterfall</b>	D 151/7	103
<b>Waterfall</b>	D 151/4	103
<b>Waterfall</b>	D 151/2	103
<b>Waterfall</b>	D 151/16	103
<b>Waterfall</b>	D 151/1	103
<b>Waterfall</b>	B 152/90	103
<b>Waterfall</b>	B 151/40	102
<b>Waterfall</b>	B 151/29	102
<b>Waterfall</b>	B 151/20	102
<b>Waterfall</b>	B 151/10	102
<b>Well</b>	893/40 PA	133

## numerical index

<b>1041/16 L</b>	Mercury	326	<b>767/5 A</b>	Cubick	227	<b>810/95 M</b>	Heron	121
<b>1041/16 P</b>	Mercury	323	<b>767/5 L</b>	Cubick	232	<b>810/95 PA</b>	Heron	113
<b>1041/40 L</b>	Mercury	326	<b>767/7 A</b>	Cubick	227	<b>810/95 S</b>	Heron	120
<b>1041/40 P</b>	Mercury	323	<b>767/7 L</b>	Cubick	232	<b>850/1 S</b>	E.R.	78
<b>1041/40 S</b>	Mercury	320	<b>767/9 A</b>	Cubick	227	<b>853/1 P</b>	Stone	85
<b>1041/40 T</b>	Mercury	325	<b>767/9 L</b>	Cubick	232	<b>855/1 P</b>	Iron	89
<b>1041/50 L</b>	Mercury	326	<b>768/5 P</b>	Cubick	228	<b>858/13 S</b>	Spin	295
<b>1041/50 P</b>	Mercury	323	<b>768/5 S</b>	Cubick	231	<b>858/13 T</b>	Spin	296
<b>1041/50 S</b>	Mercury	320	<b>768/7 P</b>	Cubick	228	<b>860/20 A</b>	Square	207
<b>137/150 A</b>	Adjustable	280	<b>768/7 S</b>	Cubick	231	<b>862/16 PA</b>	Olimpia	193
<b>630/30 L</b>	Nuvola	317	<b>768/9 P</b>	Cubick	228	<b>864/60 S</b>	Nassa	185
<b>630/30 PA</b>	Nuvola	313	<b>768/9 S</b>	Cubick	231	<b>864/80 S</b>	Nassa	185
<b>630/30 PA</b>	Nuvola	314	<b>770/21 A</b>	Abbraccio	250	<b>865/18 S</b>	Ball	63
<b>630/30 S</b>	Nuvola	311	<b>770/36 A</b>	Abbraccio	250	<b>867/12 S</b>	Cone	67
<b>630/50 L</b>	Nuvola	317	<b>770/70 A</b>	Abbraccio	250	<b>870/100 S</b>	Katana	173
<b>630/50 PA</b>	Nuvola	313	<b>773/20 P</b>	Plateau	275	<b>870/100 S2</b>	Katana	175
<b>630/50 PA</b>	Nuvola	314	<b>773/30 P</b>	Plateau	275	<b>870/130 S</b>	Katana	173
<b>630/50 S</b>	Nuvola	311	<b>773/40 P</b>	Plateau	275	<b>870/130 S2</b>	Katana	175
<b>754/30 A</b>	Tratto	242	<b>773/52 P</b>	Plateau	275	<b>870/200 T</b>	Katana	179
<b>754/30 PA</b>	Tratto	245	<b>773/52 S</b>	Plateau	273	<b>879/60 S</b>	Biquadro	213
<b>754/30 PA IP</b>	Tratto	245	<b>773/60 P</b>	Plateau	275	<b>891/120 S</b>	Kami	146
<b>754/30A IP</b>	Tratto	242	<b>773/60 S</b>	Plateau	273	<b>891/30 A</b>	Kami	150
<b>754/60 A</b>	Tratto	240	<b>774/60 A</b>	Tratto	243	<b>891/90 S</b>	Kami	146
<b>754/60 PA</b>	Tratto	245	<b>774/60 A IP</b>	Tratto	243	<b>892/15 A</b>	Volvit	157
<b>754/60 PA IP</b>	Tratto	245	<b>774/90 A</b>	Tratto	243	<b>892/18 A</b>	Volvit	157
<b>754/60A IP</b>	Tratto	240	<b>774/90A IP</b>	Tratto	243	<b>893/40 PA</b>	Well	133
<b>754/90 A</b>	Tratto	240	<b>775/180 T</b>	Bambù	307	<b>894/30 C</b>	Thesis	141
<b>754/90 PA</b>	Tratto	245	<b>775/90 S</b>	Bambù	304	<b>894/60 PA</b>	Thesis	139
<b>754/90 PA IP</b>	Tratto	245	<b>776/1 S</b>	Stretch	43	<b>894/70 PA</b>	Thesis	139
<b>754/90 S</b>	Tratto	237	<b>777/90 S</b>	Bambù	304	<b>895/70 P</b>	Ninfea	169
<b>754/90A IP</b>	Tratto	240	<b>780/14 S</b>	Nuts	56	<b>895/90 P</b>	Ninfea	169
<b>755/30 PA</b>	Bolle	257	<b>782/170 S</b>	Plane	287	<b>896/120 S</b>	Dinamica	126
<b>755/30 S</b>	Bolle	255	<b>782/170 T</b>	Plane	288	<b>896/60 S</b>	Dinamica	126
<b>755/60 PA</b>	Bolle	257	<b>783/11 S</b>	Time	30	<b>896/80 S</b>	Dinamica	126
<b>755/60 S</b>	Bolle	255	<b>784/16 S</b>	Mini Mercury	36	<b>897/60 P</b>	Basalt	161
<b>761/10 A</b>	Quadretto	217	<b>785/16 S</b>	Mini Soft	20	<b>899/5 A</b>	Cubick	225
<b>764/100 PA</b>	Fuorisquadra	263	<b>786/13 S</b>	Drop	12	<b>899/7 A</b>	Cubick	225
<b>764/100 S</b>	Fuorisquadra	261	<b>810/120 AD</b>	Heron	107	<b>899/9 A</b>	Cubick	225
<b>764/25 PA</b>	Fuorisquadra	263	<b>810/120 AS</b>	Heron	107	<b>B 151/10</b>	Waterfall	102
<b>764/35 PA</b>	Fuorisquadra	263	<b>810/120 M</b>	Heron	121	<b>B 151/20</b>	Waterfall	102
<b>764/50 PA</b>	Fuorisquadra	263	<b>810/120 PA</b>	Heron	113	<b>B 151/29</b>	Waterfall	102
<b>764/50 S</b>	Fuorisquadra	261	<b>810/120 S</b>	Heron	120	<b>B 151/40</b>	Waterfall	102
<b>764/64 PA</b>	Fuorisquadra	263	<b>810/15 R2</b>	Heron	121	<b>B 152/90</b>	Waterfall	103
<b>764/64 S</b>	Fuorisquadra	261	<b>810/15 R3</b>	Heron	121	<b>D 151/1</b>	Waterfall	103
<b>765/100 PA</b>	Biscotto	269	<b>810/75 AD</b>	Heron	107	<b>D 151/16</b>	Waterfall	103
<b>765/100 S</b>	Biscotto	267	<b>810/75 AS</b>	Heron	107	<b>D 151/2</b>	Waterfall	103
<b>765/130 PA</b>	Biscotto	269	<b>810/75 PA</b>	Heron	113	<b>D 151/4</b>	Waterfall	103
<b>765/130 S</b>	Biscotto	267	<b>810/95 AD</b>	Heron	107	<b>D 151/7</b>	Waterfall	103
<b>765/60 PA</b>	Biscotto	269	<b>810/95 AS</b>	Heron	107	<b>M 151</b>	Waterfall	103



## Design Materiali Funzionalità

Design • Materials • Functionality  
Design • Materialien • Funktionalität

L'innovativa ricerca di materiali con i propri collaboratori personalizza i prodotti, aiutando il cliente in una scelta mirata al proprio stile. Alta qualità e buon Design Italiano caratterizzano il team di artigiani che collaborano con Cattaneo Illuminazione progettando con eleganza lo "Spazio illuminazione" per trasformare il lavoro in un vero e proprio laboratorio di idee.

The innovative research for materials in cooperation with its own partners personalizes the products, helping customers choosing the most suitable fitting for their style. High quality and good Italian Design distinguish the team of artisans cooperating with Cattaneo Illuminazione for the elegant design of the "Lighting Field", to transform work into a real ideas' studio.

Unsere Mitarbeiter bemühen sich stets um neue Materialien und innovative Forschung um den Kunden eine bestmögliche Auswahl zu bieten. Hohe Qualität und ein gutes Design wurden vom italienischen Team von Handwerkern charakterisiert. In der Zusammenarbeit mit der Entwicklung von Fa. Cattaneo Illuminazione wurde mit viel Eleganz ein Lichtraum erschaffen.



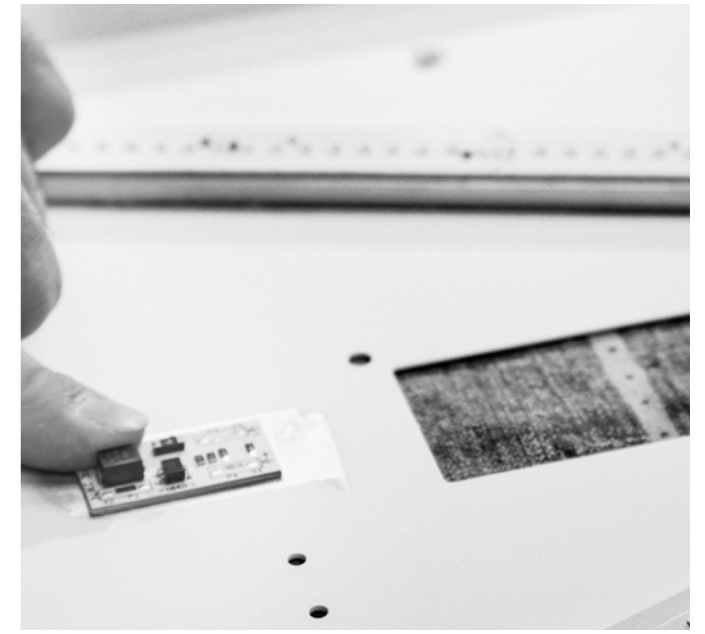

Le tecnologie ci aiutano a vivere i nostri attimi quotidiani e anche nell'illuminazione la ricerca e lo sviluppo di nuovi sistemi illuminanti ha permesso a Cattaneo Illuminazione di creare e ottimizzare nuovi apparecchi, attenti, non solo alle esigenze del mercato, ma anche alla giusta relazione tra persona, ambiente e corretta visione della luce.

La sinergia tra creatività e tecnologia ha potuto creare lampade a basso consumo energetico e a LED con alte prestazioni illuminotecniche, che grazie all'utilizzo di schermi protettivi e alla ricerca nella disposizione del bulbo illuminante, permettono un'ergonomica e corretta illuminazione nell'ambiente.

Da oltre quarant'anni, Cattaneo Illuminazione propone creazioni che scaturiscono dalla fantasia e dalla manualità di qualificati artigiani italiani. La ricerca estetica, l'attenta selezione dei materiali, accurata esecuzione

Technology helps us in our daily lives; as for lighting, research and development have allowed Cattaneo Illuminazione to design and optimize new light fixtures aimed at meeting the needs of the market, as well as providing people and interiors with suitable lighting solutions. Synergy between creativity and technology has led to the design of low-energy and LED, high-performance lamps, fitted with appropriate screens and specially-positioned bulbs so as to ensure a suitable ergonomic interior lighting.

For over forty years, Cattaneo Illuminazione has been offering lighting creations arising from the imagination and craftsmanship of skilled Italian artisans. Aesthetic research, careful selection of materials and accurate finishes are combined to offer top quality products, exclusively made in Italy and Europe.

Technologien helfen unsere alltaeglichen Momente zu leben, das gilt auch fuer die Beleuchtung die durch Forschung, Entwicklung und Ausruestung neuer Beleuchtungssysteme von Cattaneo Illuminazioni nicht nur auf die Marktbeduefnisse sondern auch auf die Beziehung zwischen Mensch, Umwelt und die richtige Vision von Licht konzipiert sind. Durch die Sinergie von Kreativitaet und Technologien ist es gelungen, energieeffiziente Lampen und LED Beleuchtung mit hoher Leistung, ausgestattet mit einer Schutzscheibe und der richtigen Anordnung der Gluehbirne, eine optimale Beleuchtung und ergonomische Umwelt zu ermoeeglichen.

Seit über vierzig Jahren bietet Cattaneo Illuminazioni, Kreationen, welche aus der Phantasie und Kunstfertigkeit des Italienischen Handwerk, entstehen. Das Aussehen, die sorgfältige Auswahl der Materialien, präzise Ausführungen, all dies ermöglicht es uns, qualitativ hochwertige Produkte anzubieten,

delle finiture: tutto ciò consente di offrire prodotti di alta qualità, che vengono sempre realizzati esclusivamente in Italia ed in Europa.

Con l'esperienza e l'organizzazione Cattaneo Illuminazione offre un full-service all'installatore o architetto, in modo tale che questi possano arricchire e integrare nel proprio progetto maggiori informazioni per i loro clienti. La velocità del customer services è lo strumento preferito dalla Cattaneo illuminazione per poter creare un rapporto di fiducia e professionalità con il cliente, ed è proprio da questo atteggiamento che scaturiscono idee e progetti interessanti soprattutto nell'ambito della fornitura di hotel, open space e grandi installazioni.

L'entusiasmo di Cattaneo illuminazione vuole essere: "La scintilla di creatività che dall'Italia illumina il mondo".

Thanks to its experience and organization, Cattaneo Illuminazione can provide architects and installers with a full service, including extensive project and technical support. A prompt customer service is of utmost importance for Cattaneo Illuminazione to establish a trustworthy, professional relationship with its customers, which is the basis of interesting ideas and projects, especially as far as hotels, open spaces and large installations are concerned.

Cattaneo Illuminazione is the spark of Italian creativity that lights up the world.

die ausschliesslich in Europa und Italien hergestellt werden.

Basierend auf die Erfahrung und der Organisation bietet Cattaneo Illuminazione einen umfassenden Service fuer Installateure und Architekten, damit deren Kundenprojekte entsprechend bereichert, sowie mit mehr Informationen entsprechend integriert werden koennen. Die Geschwindigkeit und ein ausgepraegter Customer Service ist fuer Cattaneo Illuminazioni, der entscheidende Aspekt, eine professionelle Vertrauensbasis mit den Kunden zu schaffen, um Ideen und interessante Projekte, vor allem in der Ausstattung von Hotel, Freiflächen und großen Installationen, zu entwickeln.

Ein Funken an Kreativitaet welcher von Italien aus die Welt beleuchtet entspricht dem Entusiasmo von Cattaneo Illuminazioni.

Art direction  
Debonademeo

Graphic design  
Bordegoni

Photography  
Bordegoni

Copyright © Cattaneo sas 2020

Reference images by gracious permission  
of our customers

Cattaneo Illuminazione si riserva la facoltà di modificare, in qualsiasi momento e senza preavviso, le caratteristiche tecniche dei modelli illustrati nel presente catalogo. I colori si intendono indicativi.

Cattaneo illuminazione reserves the right to change the technical features of the items in the catalogue at any time without prior notice.

The colours shown are intended to show the approximate colour of the finish.

Cattaneo Illuminazioni behält sich das Recht vor, jederzeit und ohne vorherige Ankündigung, die technischen Eigenschaften der Modelle in diesem Katalog zu modifizieren. Die Farben sind indikativ.

**Cattaneo**

Via P. da Volpedo, 10  
20092 Cinisello Balsamo

Milano - Italy

t. (+39) 02 6604.6582

t. (+39) 02 6601.8303

cattaneo@cattaneo.it

export@cattaneo.it

[www.cattaneo.it](http://www.cattaneo.it)

**tomorrow**



new lighting atmospheres